

Altitude kit

Installation instructions.



Air pressure sensor for heating at high altitudes.



Eberspächer

1 Introduction

Contents

Chapter	Title	Chapter contents	Page
1	Introduction	<ul style="list-style-type: none"> • Please read first 3 • General information/ safety instructions 3 • Altitude kit contents 3 • Intended use..... 3 • Compatibility..... 3 • Technical data..... 3 	
2	Description of functions	<ul style="list-style-type: none"> • Description of functions 4 	
3	Installation	<ul style="list-style-type: none"> • Installation location 4 • Electrical connection..... 5 • Connecting the Plus supply 5 	
4	Functional check / Diagnosis	<ul style="list-style-type: none"> • Functional check 6 • Diagnosis..... 6 • Fault code display / air pressure sensor 6 	
5	What to do if ...?	<ul style="list-style-type: none"> • Heater malfunction 7 • Malfunction when using the EasyStart R / EasyStart R+ / EasyStart T controls..... 7 • Malfunction when using the AIRTRONIC mini controller..... 7 • Malfunction during the functional check..... 7 	
6	Circuit diagrams	<ul style="list-style-type: none"> • Parts lists for the circuit diagrams 8 • AIRTRONIC / AIRTRONIC M / AIRTRONIC L 9 – 15 <ul style="list-style-type: none"> – Air pressure sensor and mini controller – Air pressure sensor, mini controller and EasyStart R – Air pressure sensor, EasyStart R and EasyStart T – Air pressure sensor and EasyStart R+ – Air pressure sensor, EasyStart R+ and EasyStart T – Air pressure sensor and EasyStart T – Air pressure sensor and EasyStart T (2x) • AIRTRONIC-ADR / AIRTRONIC M-ADR / AIRTRONIC L-ADR..... 16, 17 <ul style="list-style-type: none"> – Air pressure sensor and EasyStart T – Air pressure sensor and EasyStart T (2x) • HYDRONIC B 4 W S / B 5 W S / B 4 W SC / B 5 W SC..... 18 – 23 <ul style="list-style-type: none"> – Air pressure sensor and EasyStart T – Air pressure sensor and EasyStart T (2x) – Air pressure sensor and EasyStart R+ – Air pressure sensor, EasyStart R+ and EasyStart T – Air pressure sensor and EasyStart R – Air pressure sensor, EasyStart R and EasyStart T 	



1 Introduction

Please read first

Before you start to install the air pressure sensor, please ensure you carefully read through these installation instructions.

These installation instructions contain important information, which you require to install the air pressure sensor.

General information / safety instructions

All information and notes, in particular the safety information in these installation instructions and in the heater's technical description must be observed at all times!

Scope of supply

Order No. 22 1000 33 22 00

Quantity / Designation

- 1 Air pressure sensor
- 2 Self-tapping screws, B 3.9 x 19 for fixing the air pressure sensor
- 5 Bush contacts – Junior Power Timer, 0.25 – 0.5 mm²
- 5 Bush contacts – Junior Power Timer, 0.5 – 1.0 mm² (for double connection)
- 1 Bush housing - Junior Power Timer, 9-pin
- 1 Retaining clip for bush housing, 9-pin
- 1 Cap with lever for bush housing, 12-pin
- 1 Adapter cable
- 1 Lead harness
- 1 Installation instructions

Purpose

The air pressure sensor is used in conjunction with the heater's control box for heating at high altitudes.

Compatibility

Before installing, refer to the JE Service Portal and / or call the JE Service Hotline to check the compatibility of the heater, air pressure sensor and control.

JE Service Portal

- <https://partner.eberspaecher.com>

JE Service Hotline within Germany

- Tel. 0800 12 34 300
- Fax 01805 26 26 24

Outside Germany, please contact the respective national Eberspächer representative.

Technical data

max. allowable altitude:	approx 4000 m
Measuring range:	600 hPa to 1150 hPa
Rated voltage:	12 volt / 24 volt
Operating voltage:	8 Volt to 32 Volt
Dimensions:	76 x 76 x 29 mm
Operating temperature:	-40 °C to +85 °C



Important!

Safety instructions for technical data!

Failure to comply with the technical data can result in malfunctions.

Please note!

If no limit values are given, the technical data listed is with the usual tolerances of $\pm 10\%$ at nominal voltage, 20 °C ambient temperature and Esslingen reference altitude.

2 Description of functions

Description of functions

After starting the heater, the air pressure sensor cyclically measures the atmospheric air pressure and transfers the measured values to the heater's control box.

The control box analyses the measured values and if necessary adjusts the metering pump's fuel delivery rate to the current, atmospheric air pressure.

The delivery rate is reduced from approx. 1400 m, this simultaneously causes a reduction in the heating output by approx. 9 % per 1000 metres.

Please note!

In addition, the heater's control action can change, i.e. the control stages in the technical data (see technical description of the heater) are no longer adhered to.

3 Installation

Installation location

Position the air pressure sensor in a clear, dry place inside the vehicle, if possible with the plug-in connection facing downwards.

Please note!

- The air pressure sensor may not be installed near ventilation discharge points or directly next to the blower motor.
- The installation space may not be airtight.
- The air pressure sensor may not be installed in an airtight packaging.



3 Installation

Electrical connection

Connect adapter cable

Push the 12-pin bush housing (4) of the adapter cable (3) into the cap (5) until it latches into place. Push in the 12-pin connector [cap (5) and bush housing (4)] at the air pressure sensor (1) until the lever automatically locks. Connect the contacts (9 and 10), as well as the 9-pin bush housing (7) to the lead harness (11) and cable loom (12). Push the retaining clip (8) into the 9-pin bush housing (7) and then connect to the 9-pin bush housing (6) of the adapter cable (3). Lay the lead harness (11) to the control and connect (the connector housing is supplied with the control).

Please note!

- The circuit diagrams for the installation are at the end of these instructions.
- Insulate and tie back unused lead harness cables (11).

Connecting the Plus supply.

It is absolutely imperative to adhere to the specified order for the power supply to the EasyStart R / EasyStart R+ EasyStart T controls.

- 1st step – apply power supply to the heater.
- 2nd step – simultaneously apply the power supply to the air pressure sensor and the control, or apply power supply to the air pressure sensor first and then to the control.

The order in which the power supply is applied must not be taken into account for any other controls.

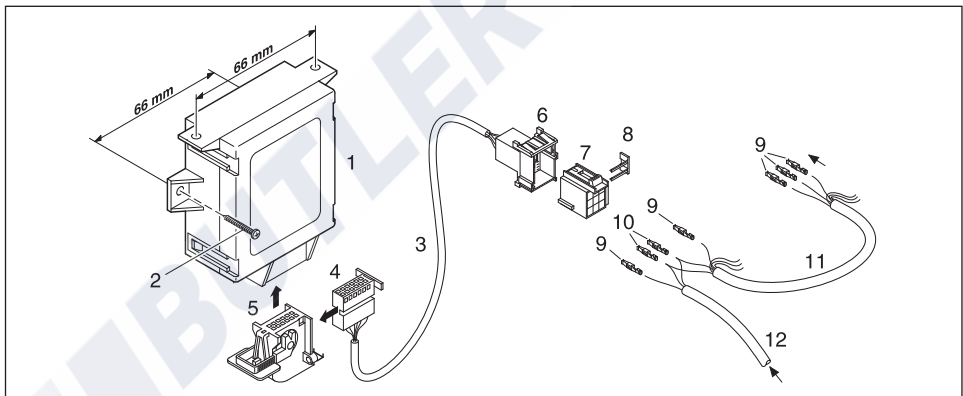

- | | |
|---------------------------------------------------------------------------------------------------------------------------------------------------------------------------------------------------------------------------------------------------------------------------------------------------------------------------------------------------------------------------------------------------------------------------|--------------------------------------------------------------------------------------------------------------------------------------------------------------------------------------------------------------------------------------------------------------------------------------------------------------------------------------------------------------------------------------------------|
| <p>1 Air pressure sensor
 2 Self-tapping screws B 3.9 x 19
 3 Adapter cable
 4 Bush housing, 12-pin
 5 Cap with lever for bush housing, 12-pin
 6 Bush housing, 9-pin (flat connector)
 7 Bush housing, 9-pin (push-on sleeves)
 8 Retaining clip for bush housing, 9-pin</p> | <p>9 Bush contacts, Junior Power Timer, 0.25 – 0.5 mm²
 10 Bush contacts, Junior Power Timer, 0.5 – 1.0 mm² (for double connection)
 11 Lead harness from adapter cable to control (included in scope of supply)
 12 Lead harness from heater to control and air pressure sensor (scope of supply: heater)</p> |
|---------------------------------------------------------------------------------------------------------------------------------------------------------------------------------------------------------------------------------------------------------------------------------------------------------------------------------------------------------------------------------------------------------------------------|--------------------------------------------------------------------------------------------------------------------------------------------------------------------------------------------------------------------------------------------------------------------------------------------------------------------------------------------------------------------------------------------------|

4 Functional check / diagnosis

Functional check

Switch on the heater with connected air pressure sensor at the control and switch it back off again as soon as the metering pump starts to pump. After the after-run has ended connect the ISO adapter with the additionally required adapter cable (Order No.: 22 1000 33 31 00) to the air pressure sensor.

Select the connected heater in the EDITH customer service program – Version S3V7-F and higher – and read out the “lowest atmospheric air pressure” via General data + Error Memory. If the “lowest atmospheric air pressure” display > 0 hPa the air pressure sensor is correctly connected and is in proper working order.

Diagnosis

The air pressure sensor connected to the heater has diagnosis capability. If errors occur during the altitude adjustment they are stored in the air pressure sensor and if necessary can be read out using the ISO adapter in conjunction with the EDITH customer service program – Version S3V7-F and higher. The adapter cable (Order No.: 22 1000 33 31 00) is also required.

Perform the diagnosis of the air pressure sensor

Disconnect the air pressure sensor / heater cable loom interface, connect the ISO adapter with the additionally required adapter cable and start the diagnosis of the air pressure sensor.

The following actions are possible:

- Read out the current error and the error memory.
- Delete the error memory.
- Query the currently measured air pressure.
- Query the operating state.
- Query the general data.

Please note!

The air pressure sensor's error memory can only be read out with the EDITH customer service program – from Version S3V7-F and higher.

It is possible to diagnose the heater when the air pressure sensor is connected

- using the EasyStart R+, EasyStart T controls.
- using the diagnostic unit, however the diagnostic unit must be connected to the “heater cable harness / cable loom” interface with an appropriate adapter cable for the heater.

Fault code display Air pressure sensor	Fault description	Comments -> Remedial action
0	No faults	—
11	Loss of communication in the diagnostics cable between the HSTG and air pressure sensor	Cable interruption in the diagnostics cable between the HSTG and air pressure sensor -> Check wiring and plug-in connections.
12	HSTG does not support high-altitude operation with the air pressure sensor	Heater connected to the air pressure sensor does not support altitude adjustment -> Use a heater which supports altitude adjustment.
13	Air pressure sensor error	The air pressure sensor is defective -> Replace the air pressure sensor



5 What to do if ...?

Heater malfunction

- Altitude adjustment is not possible.
 - Heater control box is not suitable for altitude adjustment.
 - Check wiring.
 - Air pressure sensor outside the specified measuring range.
 - Read out fault memory of the heater control box and the air pressure sensor, correct fault if necessary.
 - Air pressure sensor defect → Replace air pressure sensor.
- Heater immediately switches off or start not possible.
 - Fault exists – read out current fault or the fault memory of the heater control box.
 - In vehicles deployed for the transport of dangerous goods (ADR), the ws/rt cable is not connected to the control.

Malfunction when using the EasyStart R / EasyStart R+ / EasyStart T controls

- Heater not recognised during initial commissioning.
 - Control and air pressure sensor connectors reversed.
 - Diagnostics cable not correctly connected at the air pressure sensor.
 - During initial commissioning, no voltage at heater and / or air pressure sensor.
 - Heater control box is not suitable for “EasyStart” controls.
- Control automatically ends heating operation immediately after switching on.
 - Check wiring and plug-in contacts.
 - Check the function of the air pressure sensor (see page 6).
- The *AIRTRONIC* air heater does not adjust.
 - Check gr/rt cable and br/ws cable for correct connection.

Malfunction when using the *AIRTRONIC* mini controller

- Heater cannot be switched on.
 - Check wiring.
- Heater controls not working, runs in “High” setting only.
 - Check gr/rt cable and br/ws cable for correct connection.

Malfunction during the functional check

- If, after the functional check using the EDITH customer service program the lowest atmospheric air pressure = 0 hPa.
 - Check wiring and plug-in connections.
- The “lowest atmospheric air pressure” display is not displayed in the general data.
 - Heater does not support altitude adjustment.

6 Circuit diagrams

Parts lists for the circuit diagrams

2.15.1 Room temperature sensor
2.15.9 Outdoor temperature sensor

3.1.7 "OFF" button
3.1.16 Radio remote control button
3.1.17 "Mini controller" control unit

3.2.15 EasyStart T timer

3.3.9 EasyStart R radio remote control
(stationary unit)
3.3.10 EasyStart R+ radio remote control
(stationary unit)

3.6.1 Lead harness (adapter cable)

3.8.3 Antenna
3.8.4 Air pressure sensor

- a) Control / air pressure sensor connection at the heater
- c) Lighting, terminal "58"
- e) EasyStart T timer connection
- g) External "ON / OFF" key
- y) Tie back and insulate cables

Please note!

Connectors and bush housings are shown from the cable inlet side.

Cable colours

rt = red
bl = blue
ws = white
sw = black
gn = green
gr = grey
ge = yellow
vi = violet



6 Circuit diagrams

AIRTRONIC / AIRTRONIC M / AIRTRONIC L

Air pressure sensor and mini controller

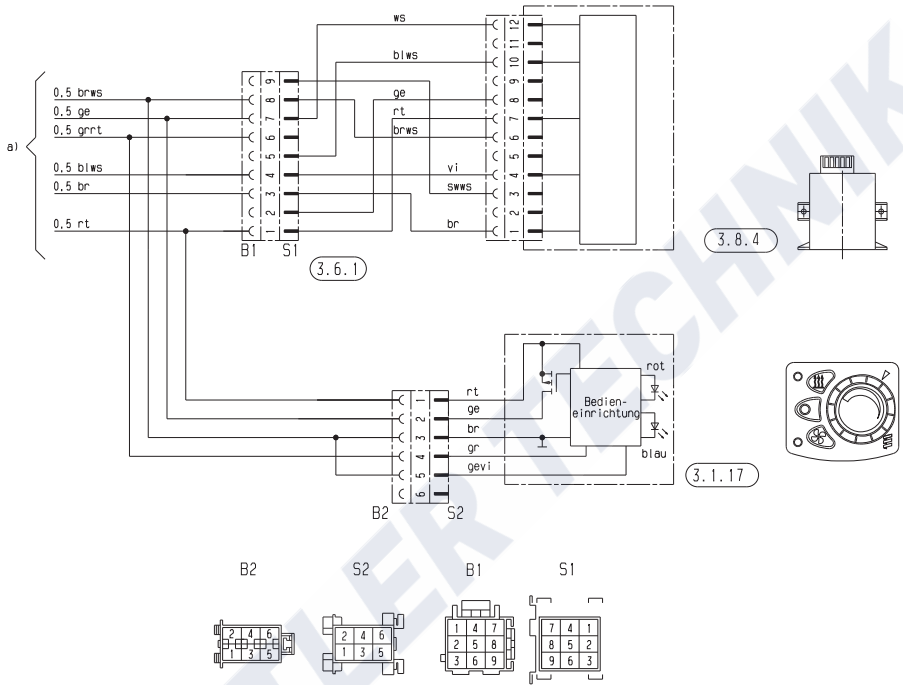

25 2361 00 97 11 A

6 Circuit diagrams

AIRTRONIC / AIRTRONIC M / AIRTRONIC L

Air pressure sensor, mini controller and EasyStart R

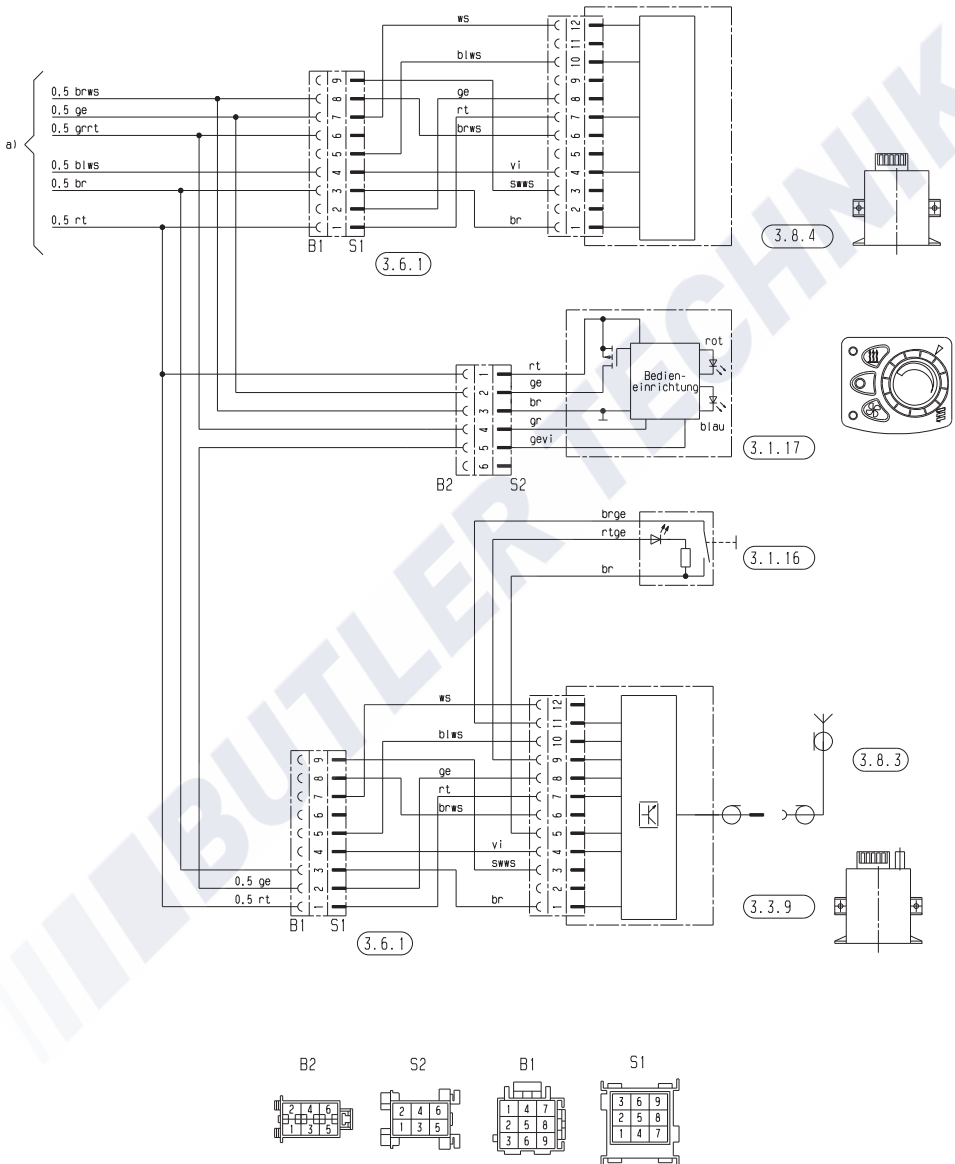



6 Circuit diagrams

AIRTRONIC / AIRTRONIC M / AIRTRONIC L
Air pressure sensor, EasyStart R and EasyStart T

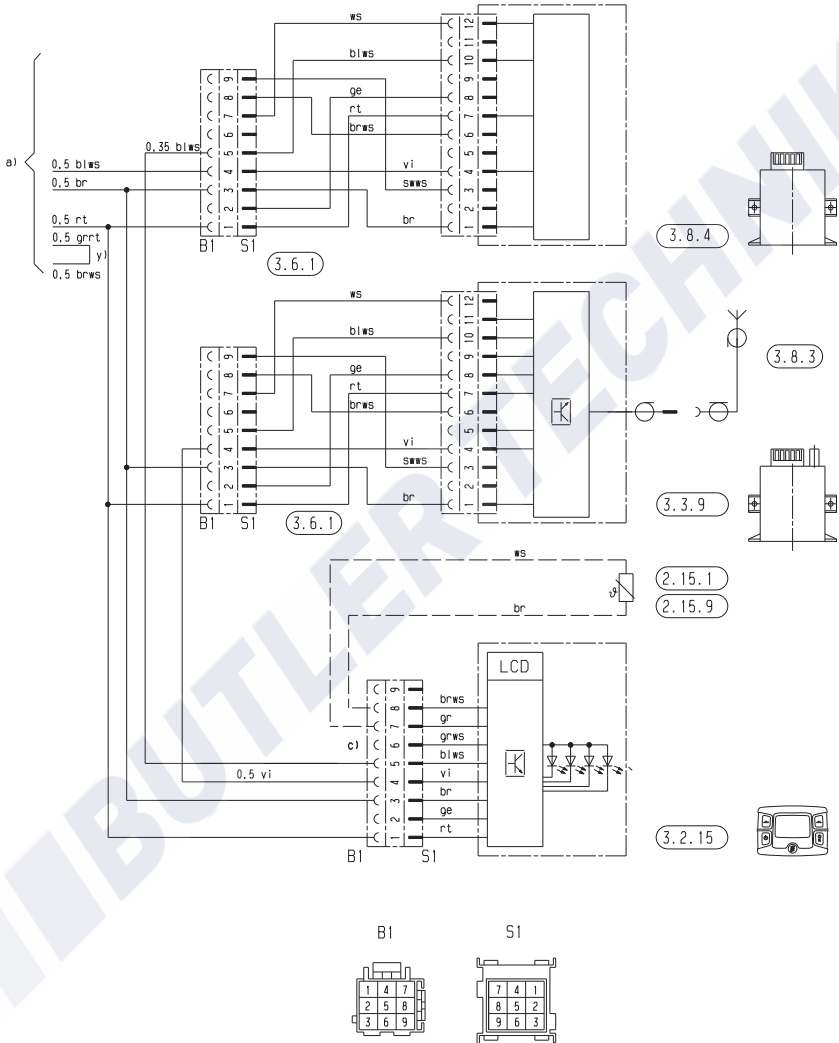

25 2361 00 97 07 A

6 Circuit diagrams

AIRTRONIC / AIRTRONIC M / AIRTRONIC L

Air pressure sensor and EasyStart R+

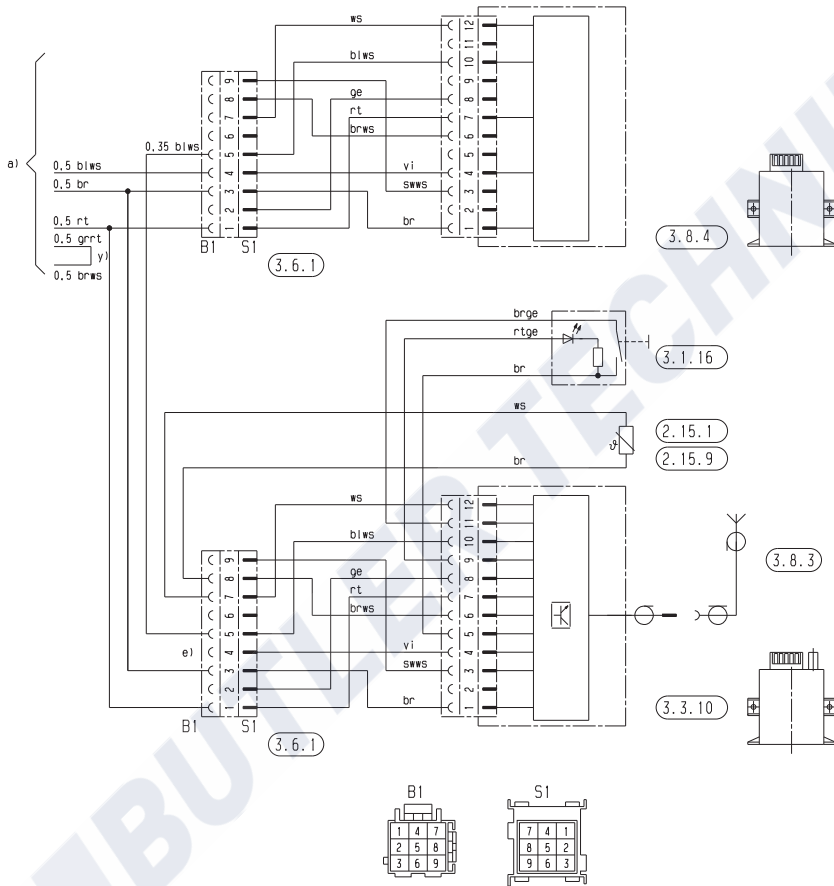

25 2361 00 97 06 A, Part 1



6 Circuit diagrams

AIRTRONIC / AIRTRONIC M / AIRTRONIC L

Air pressure sensor, EasyStart R+ and EasyStart T

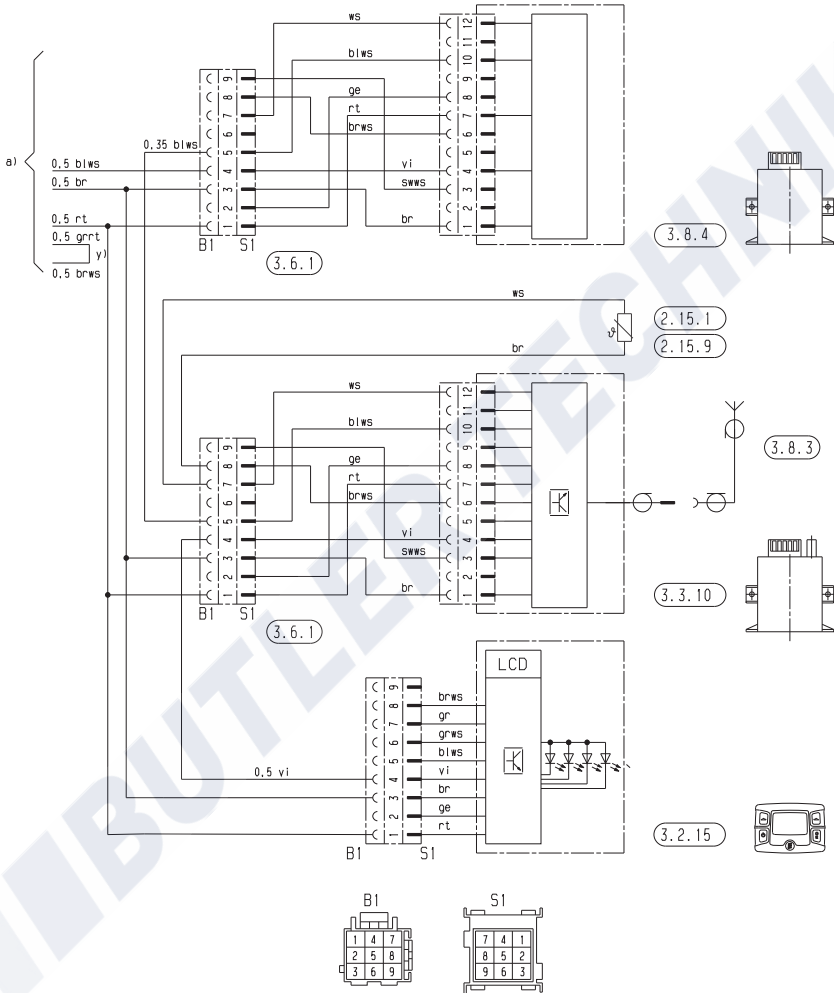

25 2361 00 97 06 A, Part 2

6 Circuit diagrams

AIRTRONIC / AIRTRONIC M / AIRTRONIC L

Air pressure sensor and EasyStart T

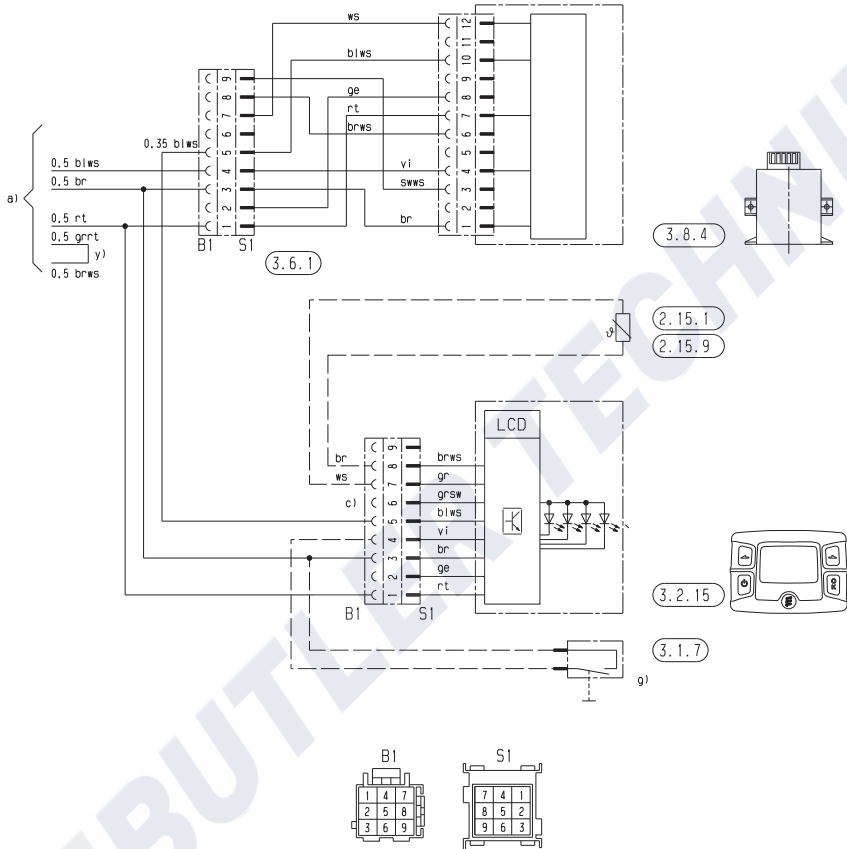

25 2361 00 97 09 A, Part 1



6 Circuit diagrams

AIRTRONIC / AIRTRONIC M / AIRTRONIC L

Air pressure sensor and EasyStart T (2x)

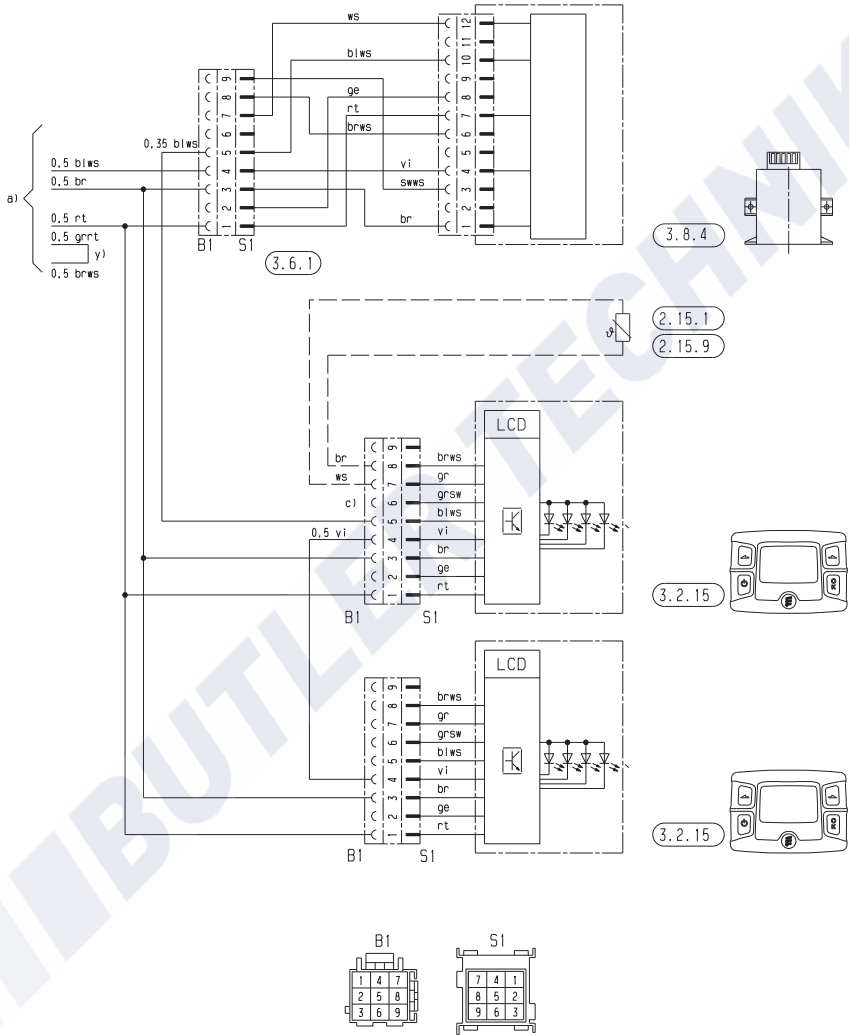

25 2361 00 97 09 A, Part 2

6 Circuit diagrams

AIRTRONIC / AIRTRONIC M / AIRTRONIC L – ADR

Air pressure sensor and EasyStart T

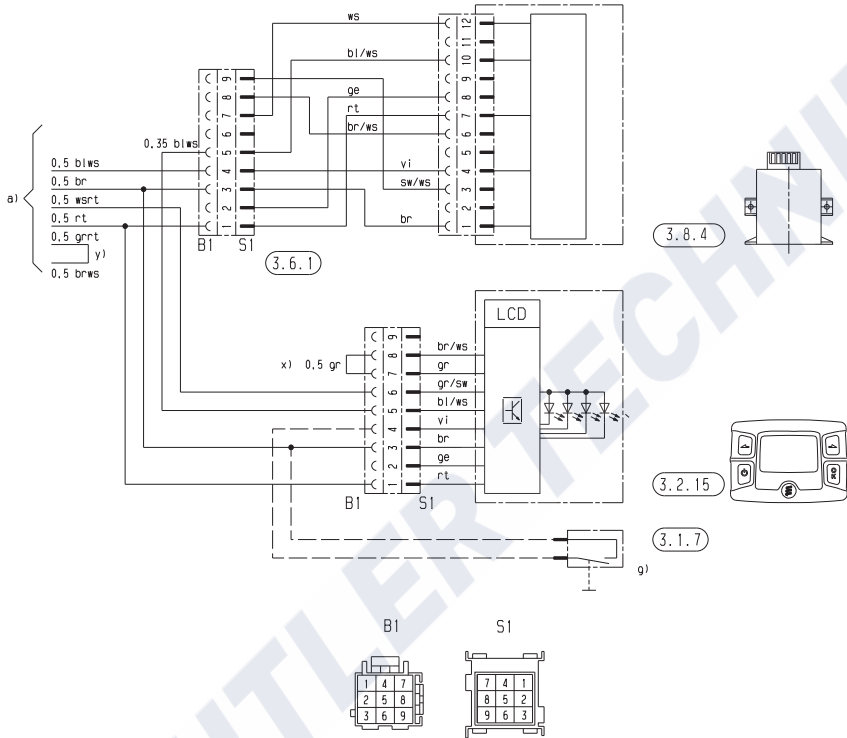

25 2361 00 97 10 A, Part 1



6 Circuit diagrams

AIRTRONIC / AIRTRONIC M / AIRTRONIC L – ADR Air pressure sensor and EasyStart T (2x)

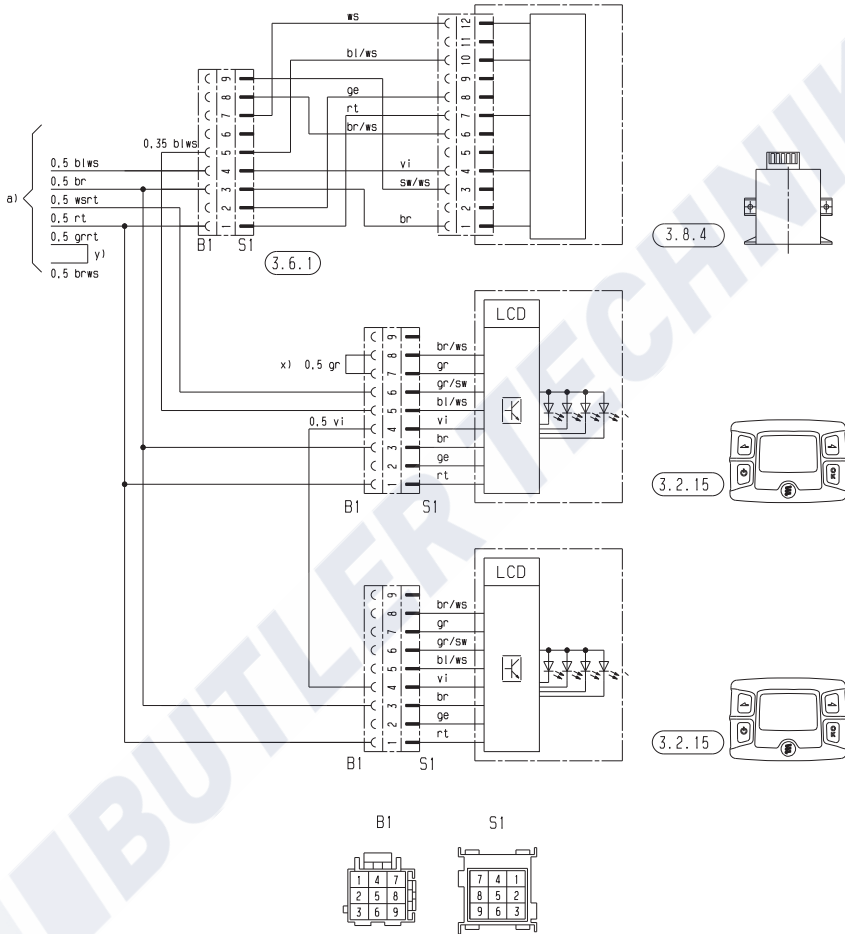

25 2361 00 97 10 A, Part 2

6 Circuit diagrams

HYDRONIC B 4 W S / B 5 W S / B 4 W SC / B 5 W SC
HYDRONIC D 4 W S / D 5 W S / D 4 W SC / D 5 W SC

Air pressure sensor and EasyStart T

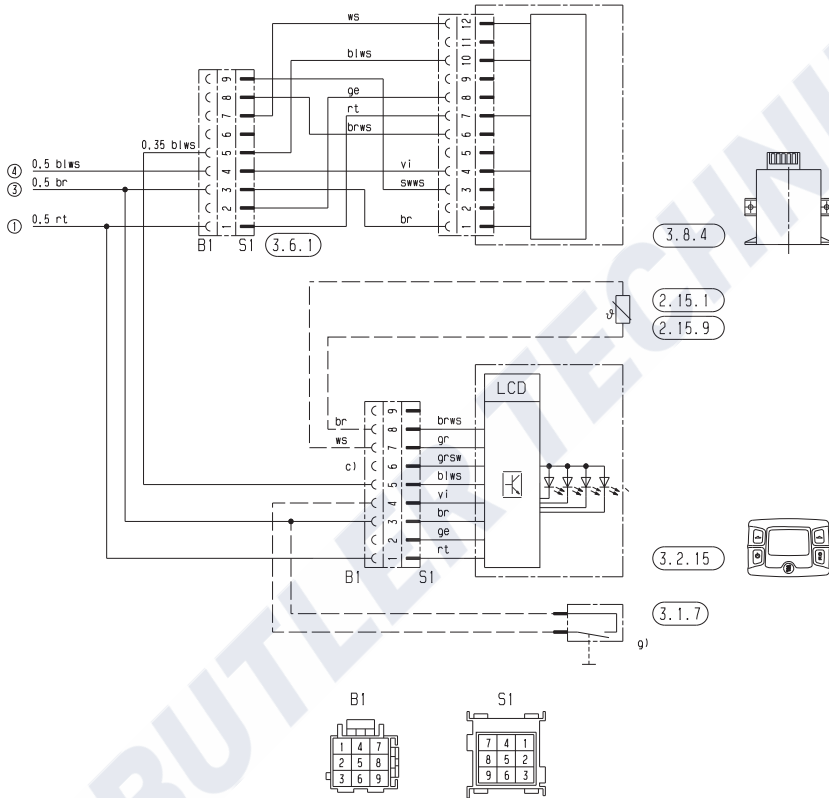

25 2217 00 97 06 A, Part 1



6 Circuit diagrams

HYDRONIC B 4 W S / B 5 W S / B 4 W SC / B 5 W SC
HYDRONIC D 4 W S / D 5 W S / D 4 W SC / D 5 W SC
 Air pressure sensor and EasyStart T (2x)

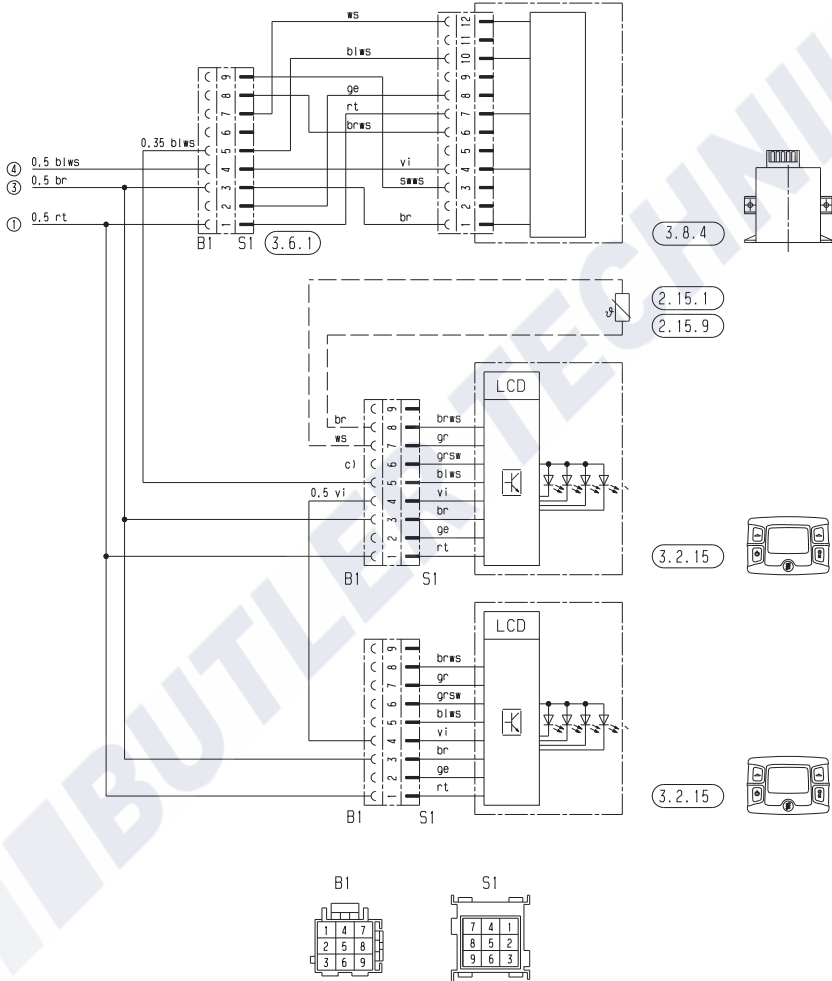

25 2217 00 97 06 A, Part 2

6 Circuit diagrams

HYDRONIC B 4 W S / B 5 W S / B 4 W SC / B 5 W SC
HYDRONIC D 4 W S / D 5 W S / D 4 W SC / D 5 W SC

Air pressure sensor and EasyStart R+

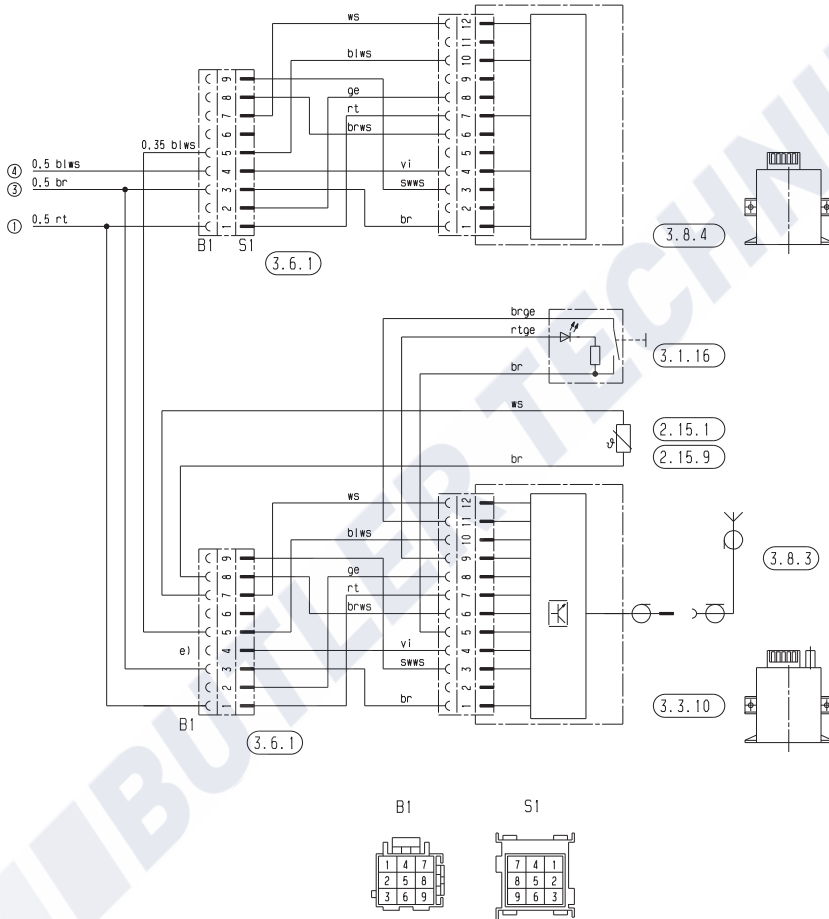

25 2217 00 97 04 A, Part 1



6 Circuit diagrams

HYDRONIC B 4 W S / B 5 W S / B 4 W SC / B 5 W SC
HYDRONIC D 4 W S / D 5 W S / D 4 W SC / D 5 W SC
 Air pressure sensor, EasyStart R+ and EasyStart T

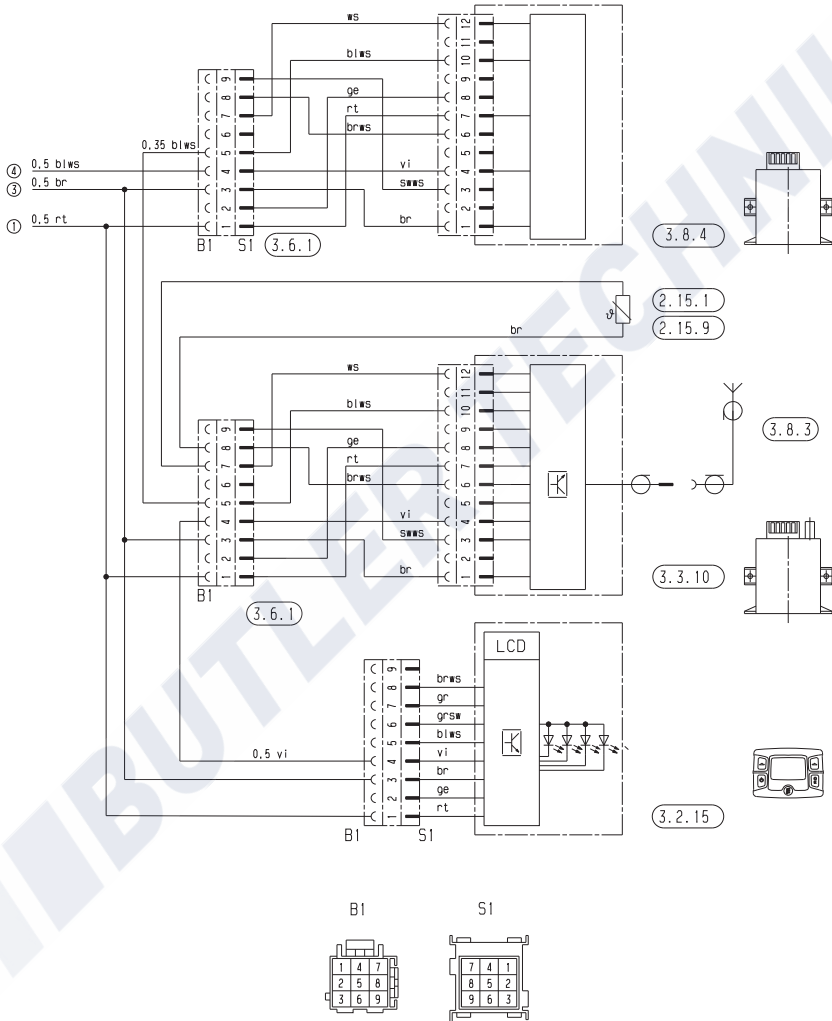

25 2217 00 97 04 A, Part 2

6 Circuit diagrams

HYDRONIC B 4 W S / B 5 W S / B 4 W SC / B 5 W SC
HYDRONIC D 4 W S / D 5 W S / D 4 W SC / D 5 W SC

Air pressure sensor and EasyStart R

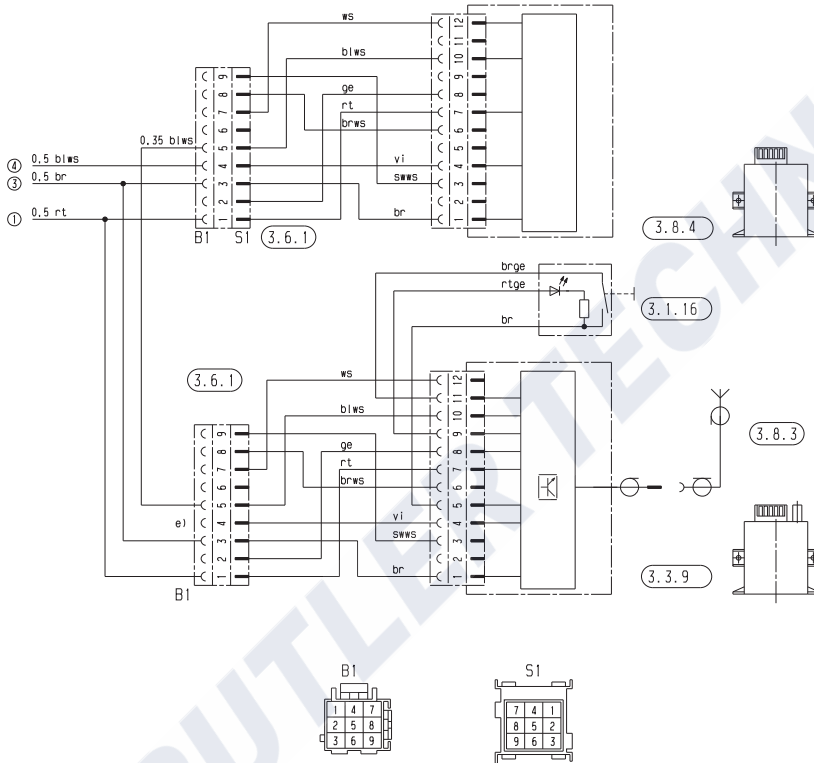

25 2217 00 97 05 A, Part 1



6 Circuit diagrams

HYDRONIC B 4 W S / B 5 W S / B 4 W SC / B 5 W SC
HYDRONIC D 4 W S / D 5 W S / D 4 W SC / D 5 W SC

Air pressure sensor, EasyStart R and EasyStart T

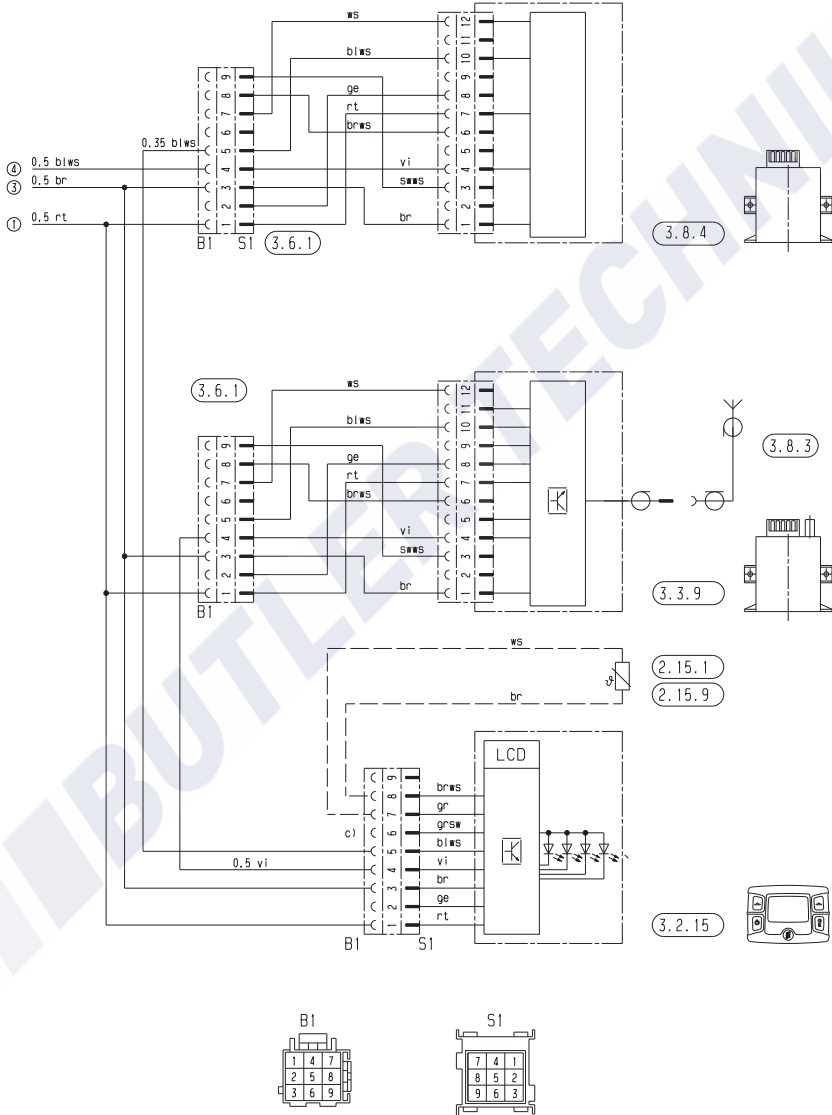

25 2217 00 97 05 A, Part 2

www.eberspaecher.com

J. Eberspächer
GmbH & Co. KG
Eberspächerstraße 24
D-73730 Esslingen
Phone 0711 939-00
Fax 0711 939-0643
info@eberspaecher.com



Eberspächer®