

SPARE PARTS LIST HYDRONIC S3 CL ECONOMY

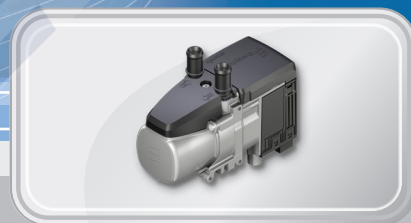

This spare parts list is valid for the following engine-independent water heaters:

Heaters for petrol	Order No.	→ 07/2017	→ 05/2020	05/2020 →
B 4 E – 12 V CL		20.1963.05.0000	20.1994.05.0000	20.2049.05.0000
B 5 E – 12 V CL		20.1952.05.0000	20.1993.05.0000	20.2048.05.0000
Heaters for diesel				
D 4 E – 12 V CL		25.2694.05.0000	25.2913.05.0000	25.2989.05.0000
D 5 E – 12 V CL		25.2652.05.0000	25.2912.05.0000	25.2971.05.0000
D 5 E – 12 V Cl-Bus			25.2984.05.0000	25.2996.05.0000
Heaters for diesel				
with inlet pressure resistant metering pump				
D 4 E – 12 V CL			25.2922.05.0000	25.2991.05.0000
D 5 E – 12 V CL			25.2921.05.0000	25.2990.05.0000

Chapter	Chapter title	Page
	Chapter contents	
1	Information	
1.1	General information	3
1.2	Reference documents	3
1.3	Determining the quantity required for the order	3
1.4	Using the nameplate to determine the production date	3
2	Heater	
2.1	Spare parts diagram	4
2.2	Spare parts list	5
2.2.1	Explanation for ordering the blower unit (item 3/3a)	5
3	Electrics and fuel system: Installation, water and combustion air system	
3.1	Spare parts diagram	10
3.2	Spare parts list	11

1 Information

1.1 General information

This document is to be used when ordering spare parts for the heaters listed on the title page, to the exclusion of all liability claims.

Depending on the version or revision status of the heater, differences may occur compared to this documentation. Please check this before ordering the spare parts and take any possible differences into account.

1.2 Reference documents

Technical description

Describes the function and proper installation and contains all information necessary for safe operation of the heater.

Repair instructions

Contains the necessary information for troubleshooting and for repair of the heater.

Installation recommendation

Describes vehicle-specific installation situations.

Installation Instructions Plus

Supplementary information on heaters and control units.

1.3 Determining the quantity required for the order

The information in the “quantity per unit” and “quantity per SU” (sales unit) columns is used to determine the quantity of a spare part required and the SU (sales units) to be ordered.

Quantity per unit

The number in this column indicates how many of the spare part concerned are installed in the whole unit.

Quantity per SU

The number in this column indicates how many of the spare part concerned are contained in one SU (sales unit).

Order No. (SU)

The order number refers to an SU.

1.4 Using the nameplate to determine the production date

To place the spare parts order correctly, in some cases it is necessary to determine the production date of the heater before ordering the spare part. There are two options for doing this on the heater's nameplate.

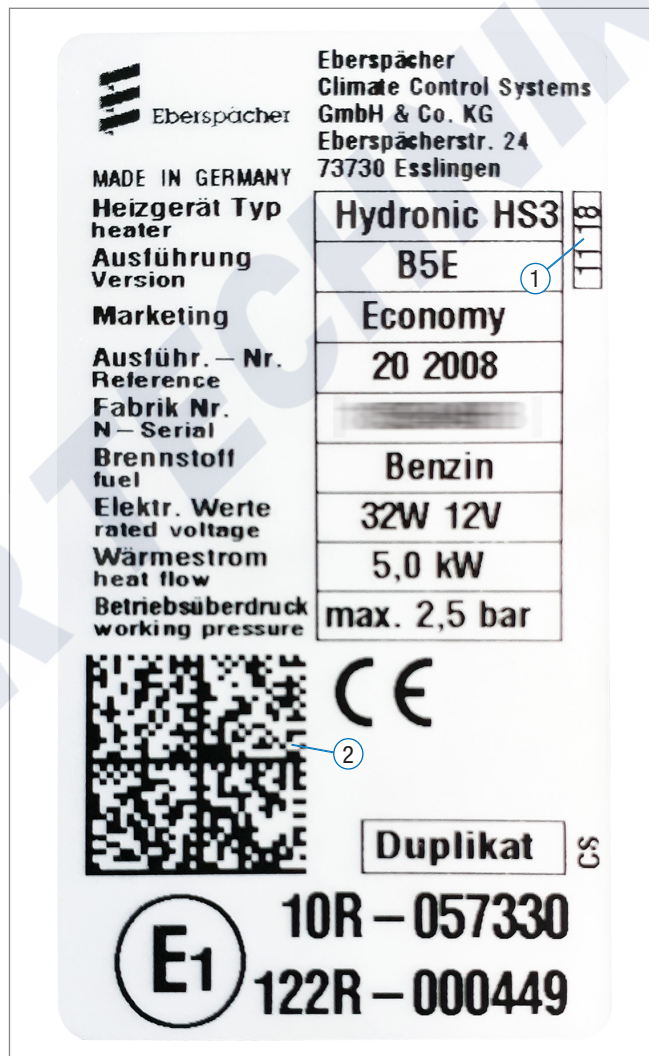

1 Determination of the calendar week

- Representation of the production calendar week as a four-digit number (e.g. “1118” = calendar week 11 in year 2018)

2 Determining the date

- Scan the QR code with a QR code reader.
- The production date is given by the 8-digit representation of the date in the third from last position of the read out text (e.g. “14032018” = 14 March 2018)

2 Heater

2.1 Spare parts diagram

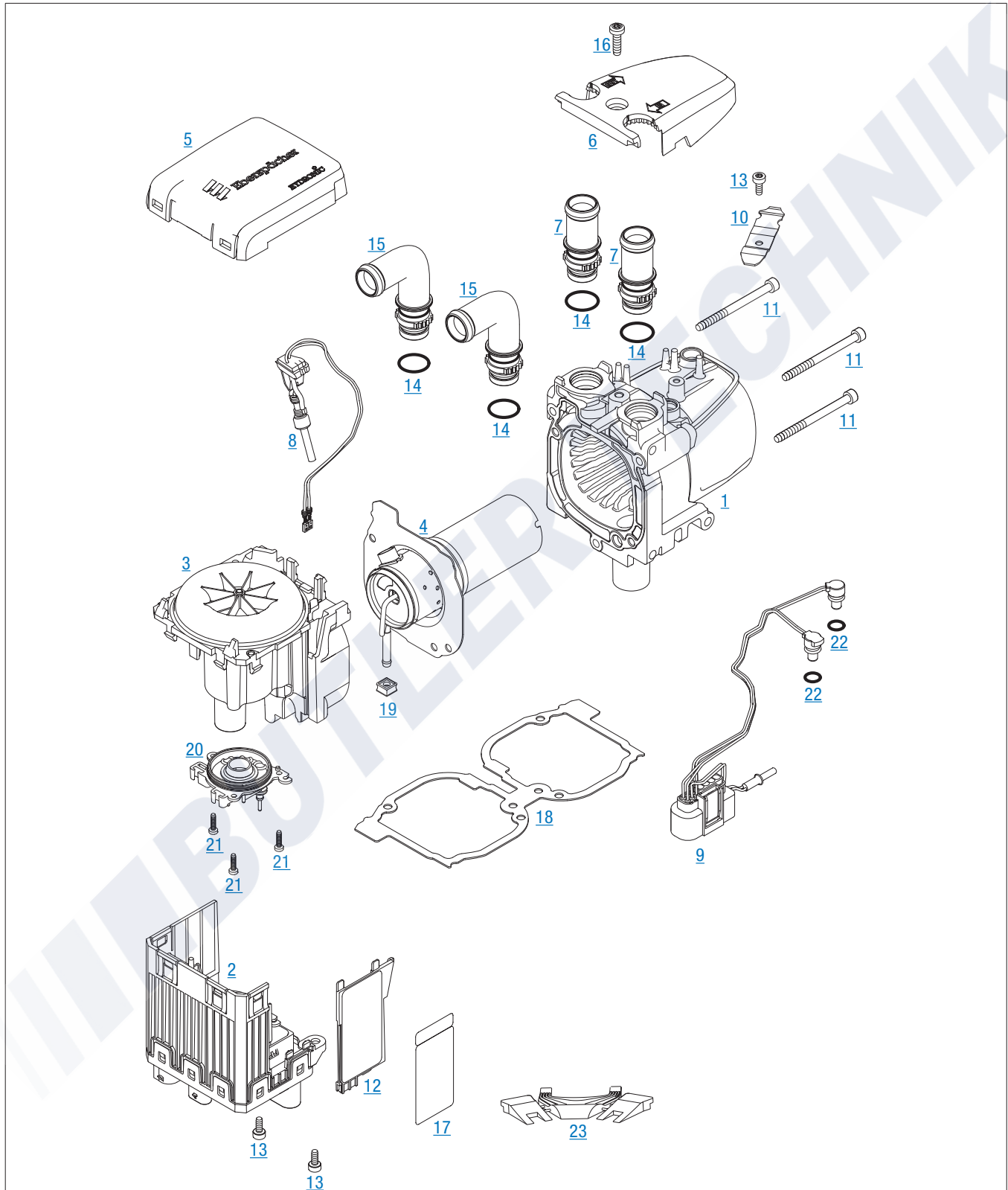

2.2 Spare parts list

2.2.1 Explanation for ordering the blower unit (item 3/3a)

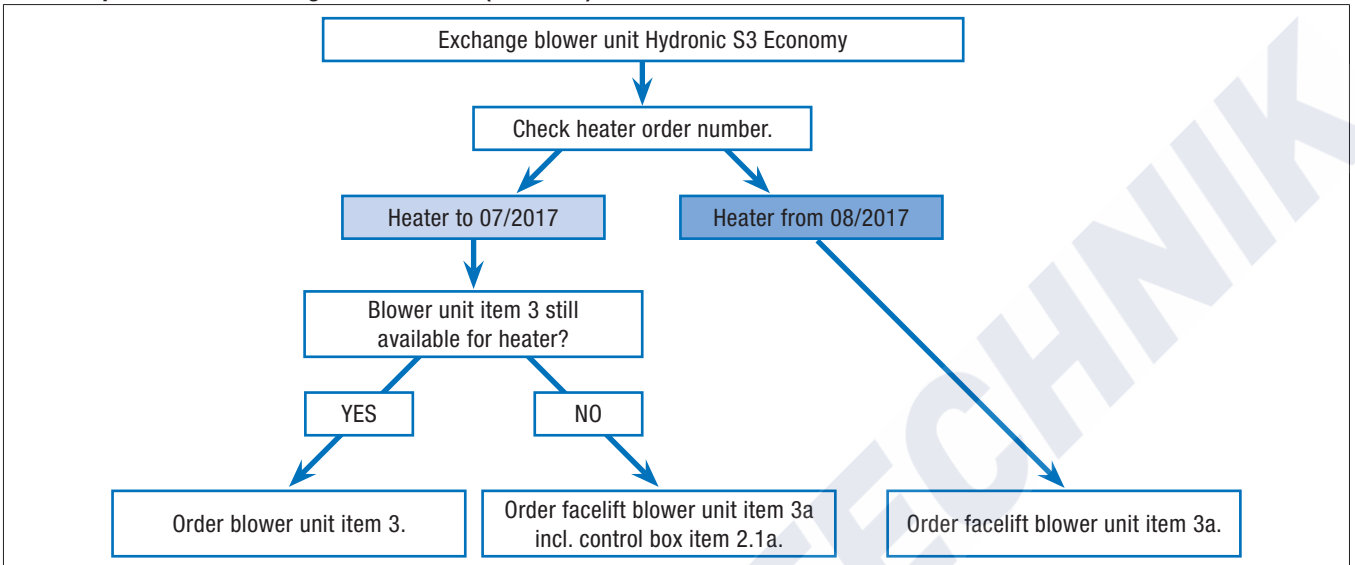

Item No.	Quantity per unit	Quantity per SU	Designation	Order No. (SU)	For unit											
					20.1963.05	20.1952.05	20.1993.05; 20.2048.05	20.1994.05; 20.2049.05	25.2694.05	25.2652.05	25.2912.05; 25.2971.05	25.2913.05; 25.2989.05	25.2921.05; 25.2990.05	25.2922.05; 25.2991.05	25.2984.05; 25.2996.05	
1	1	1	Jacket and heat exchanger	25.2651.01.0100	•	•	•	•	•	•	•	•	•	•	•	•
2	1	-	Control box Note ▪ Use the dismantling kit item 23 to dismantle the control box.	see item 2.1												
2.1	1	1	Kit – control box, includes: 2 , 13 , 17 , 20 , 21	20.1963.99.5000 20.1952.99.5000 25.2694.99.5000 25.2652.99.5000	•					•				•		

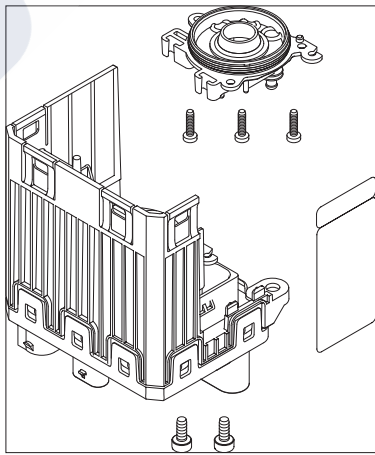

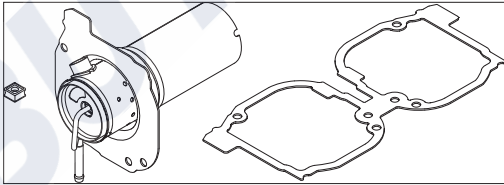
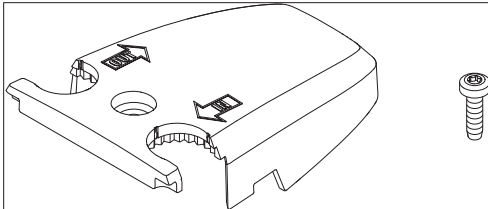
Item No.	Quantity per unit	Quantity per SU	Designation	Order No. (SU)	For unit																
					20.1963.05	20.1952.05	20.1993.05; 20.2048.05	20.1994.05; 20.2049.05	25.2694.05	25.2652.05	25.2912.05; 25.2971.05	25.2913.05; 25.2989.05	25.2921.05; 25.2990.05	25.2922.05; 25.2991.05	25.2984.05; 25.2996.05						
2.1a (not ill.)	1	1	Kit – control box, includes: 2 , 13 , 17 , 20 , 21 Note If blower item 3 can no longer be ordered, order kit – control box item 2.1a incl. blower item 3a.	20.1994.99.5000 20.1993.99.5000 25.2913.99.5000 25.2912.99.5000 25.2921.99.5000 25.2922.99.5000 25.2984.99.5000	•		•	•	•			•									
3	1	1	Blower * Note * Discontinued part – if it can no longer be ordered for the stated heaters, then order blower item 3a incl. kit – control unit item 2.1a .	25.2652.15.0000	•	•				•	•										
3 a (not ill.)	1	1	Blower	→ 05/2020: 25.2652.16.0000 05/2020 →: 25.2971.15.0000	•	•	•	•	•	•	•	•	•	•	•	•	•	•	•	•	•
4	1	–	Combustion chamber** Note ** Discontinued part – if kit – combustion chamber item 4.1 can no longer be ordered for the stated heaters, then order kit – combustion chamber 4.1a.	see item 4.1																	
4.1	1	1	Kit – combustion chamber, includes: 4 , 18 , 19 	20.1952.99.1000 25.2652.99.1000	•	•	•	•					•	•	•	•	•	•	•	•	•
5	1	1	Cover, blower	25.2652.01.0003	•	•	•	•	•	•	•	•	•	•	•	•	•	•	•	•	•
6	1	–	Cover, sensor	see item 6.1																	
6.1	1	1	Kit – cover, sensor, includes: item 6 , 16 	25.2652.99.0112	•	•	•	•	•	•	•	•	•	•	•	•	•	•	•	•	•

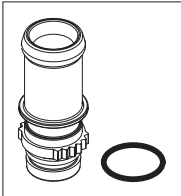
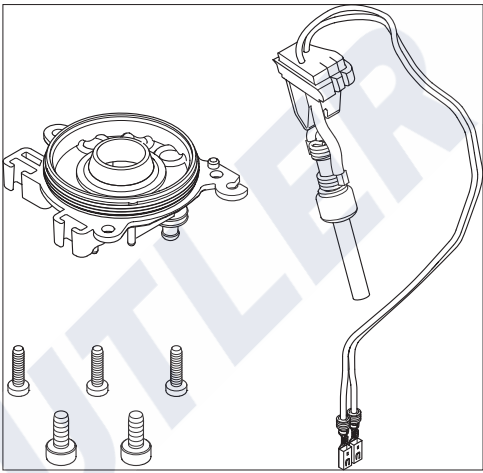
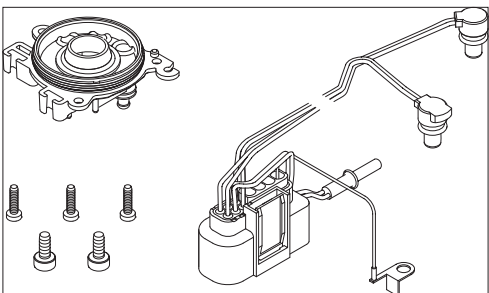
Item No.	Quantity per unit	Quantity per SU	Designation	Order No. (SU)	For unit																	
					20.1963.05	20.1952.05	20.1993.05; 20.2048.05	20.1994.05; 20.2049.05	25.2694.05	25.2652.05	25.2912.05; 25.2971.05	25.2913.05; 25.2989.05	25.2921.05; 25.2990.05	25.2922.05; 25.2991.05	25.2984.05; 25.2996.05							
7	2	–	Water connection socket 20, straight	see item 7.1																		
7.1	1	1	Kit – water connection socket 20, straight includes: item 7 , 14	25.2652.99.0501	•	•	•	•	•	•	•	•	•	•	•	•	•	•	•	•	•	
																						
8	1	–	Glow plug	see item 8.1																		
8.1	1	1	Kit – glow plug includes: item 8 , 13 , 20 , 21	25.2652.99.0109	•	•	•	•	•	•	•	•	•	•	•	•	•	•	•	•	•	
																						
9	1	–	Heater lead harness	see item 9.1																		
9.1	1	1	Kit – heater lead harness includes: item 9 , 13 , 20 , 21	25.2652.99.0102	•	•	•	•	•	•	•	•	•	•	•	•	•	•	•	•	•	
																						

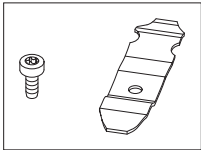
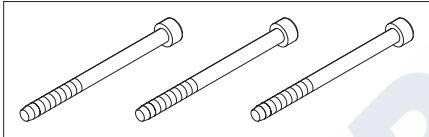
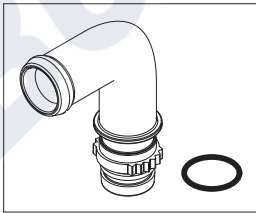
Item No.	Quantity per unit	Quantity per SU	Designation	Order No. (SU)	For unit															
					20.1963.05	20.1952.05	20.1993.05; 20.2048.05	20.1994.05; 20.2049.05	25.2694.05	25.2652.05	25.2912.05; 25.2971.05	25.2913.05; 25.2989.05	25.2921.05; 25.2990.05	25.2922.05; 25.2991.05	25.2984.05; 25.2996.05					
10	1	–	Compression spring	see item 10.1																
10.1	1	1	Kit – compression spring includes: item 10 , 13	25.2652.99.0006	•	•	•	•	•	•	•	•	•	•	•	•	•	•	•	•
																				
11	3	–	Screw, M5 × 65 thread forming, DIN 7500-EE	see item 11.1																
11.1	3	3	Kit – screw, M5 × 65 (3 ea.) includes: item 11	25.2652.01.0014	•	•	•	•	•	•	•	•	•	•	•	•	•	•	•	•
																				
12	1	1	Cover, electric motor	25.2652.01.0004	•	•	•	•	•	•	•	•	•	•	•	•	•	•	•	•
13	2	2	Screw, M4 × 10 thread forming, DIN 7500-EE	see item 2.1 , see item 8.1 , see item 9.1 , see item 10.1																
14	2	4	O-ring, 16 x 2	22.1000.70.0019	•	•	•	•	•	•	•	•	•	•	•	•	•	•	•	•
15	2	–	Water connection socket 20, angled	see item 15.1																
15.1	1	–	Kit – water connection socket 20, angled includes: item 14 , 15	25.2652.99.8001	•	•	•	•	•	•	•	•	•	•	•	•	•	•	•	•
																				
16	1	–	Screw, M5 × 18 thread forming, DIN 7500-CE	25.2652.01.0015	•	•	•	•	•	•	•	•	•	•	•	•	•	•	•	•
17	1	–	Nameplate, replacement	see item 2.1																

For unit

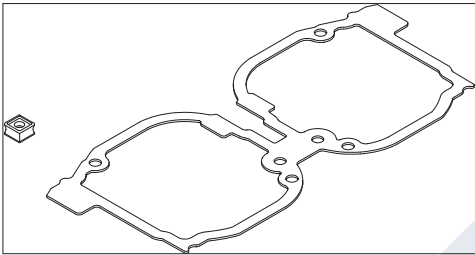
Item No.	Quantity per unit	Quantity per SU	Designation	Order No. (SU)	20.1963.05	20.1952.05	20.1993.05; 20.2048.05	20.1994.05; 20.2049.05	25.2694.05	25.2652.05	25.2912.05; 25.2971.05	25.2913.05; 25.2989.05	25.2921.05; 25.2990.05	25.2922.05; 25.2991.05	25.2984.05; 25.2996.05
18	1	–	Seal, heat exchanger	see item 18.1 , see item 4.1											
18.1	1	–	Kit – seal includes: item 18 , 19	20.1952.99.0105 25.2652.99.0105	•	•	•	•	•	•	•	•	•	•	•
															
19	1	–	Fuel pipe grommet	see item 18.1 , see item 4.1											
20	1	–	Cover, electric motor	see item 2.1 , see item 8.1 , see item 9.1											
21	3	–	Screw, M3 × 12 thread forming, DIN 7500	see item 2.1 , see item 8.1 , see item 9.1											
22	2	20	O-ring, 7.5 x 2	25.2481.99.0107	•	•	•	•	•	•	•	•	•	•	•
23	–	1	Dismantling kit for control box	25.2652.81.0000	•	•	•	•	•	•	•	•	•	•	•

3 Electrics and fuel system: Installation, water and combustion air system

3.1 Spare parts diagram

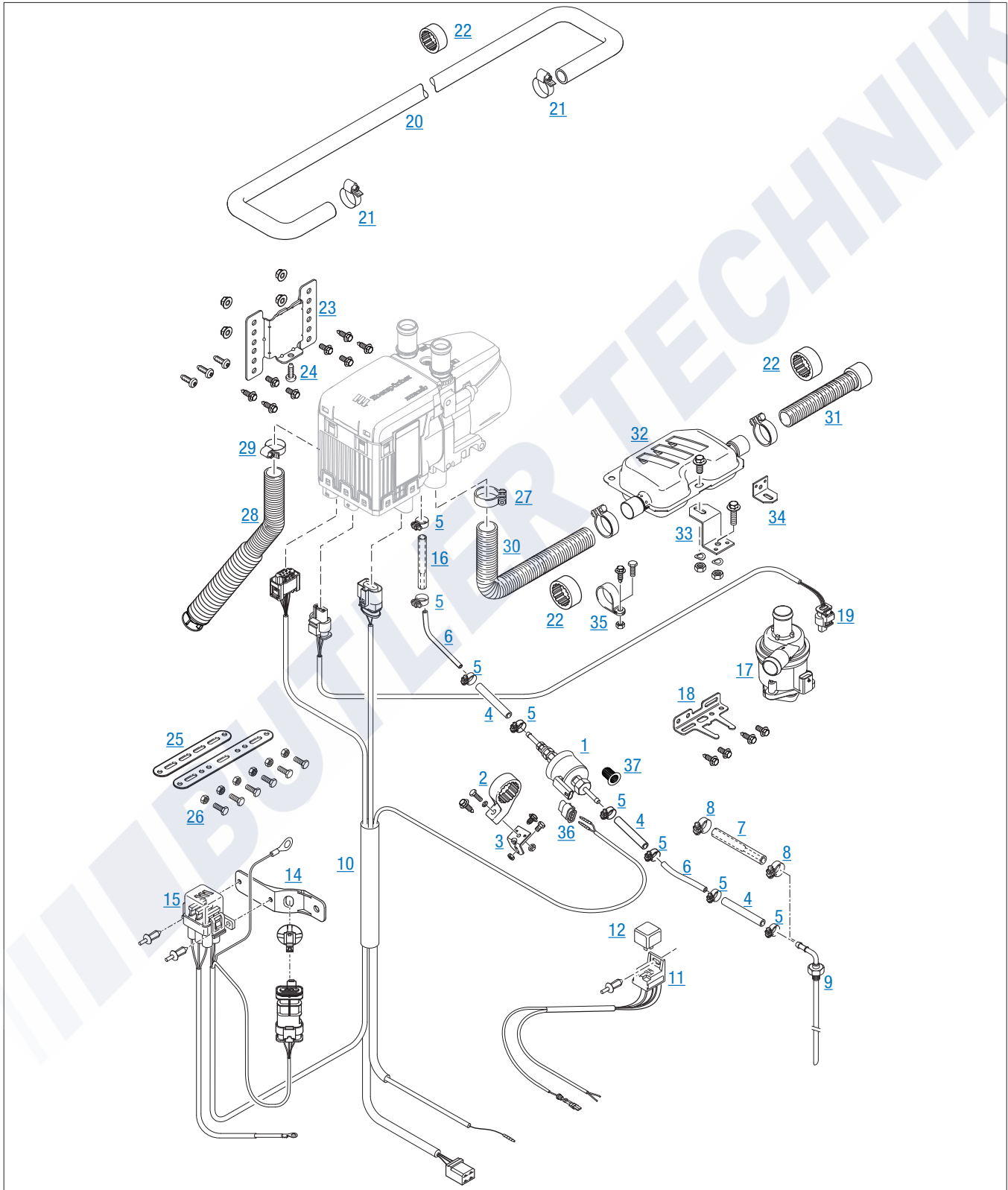

3.2 Spare parts list

Item No.	Quantity per unit	Quantity per SU	Designation	Order No. (SU)	For unit																		
					20.1963.05	20.1952.05	20.1993.05; 20.2048.05	20.1994.05; 20.2049.05	25.2694.05	25.2652.05	25.2912.05; 25.2971.05	25.2913.05; 25.2989.05	25.2921.05; 25.2990.05	25.2922.05; 25.2991.05	25.2984.05; 25.2996.05								
1	1	1	Fuel metering pump, 12 V	22.4550.05.0000	•	•	•	•	•	•	•	•	•	•	•	•	•	•	•	•	•	•	•
(not ill.)	1	1	Fuel metering pump, inlet pressure resistant, 12 V	22.4554.01.0000																			
2	1	1	Bracket fuel metering pump	22.1000.50.0400	•	•	•	•	•	•	•	•	•	•	•	•	•	•	•	•	•	•	•
3	–	1	Bracket	20.1348.03.0002	•	•	•	•	•	•	•	•	•	•	•	•	•	•	•	•	•	•	•
4	–	rm	Hose 3.5 x 3 mm	360.75.400	•	•	•	•	•	•	•	•	•	•	•	•	•	•	•	•	•	•	•
5	8	1	Hose clip, Ø 9 mm	10.2068.00.9098	•	•	•	•	•	•	•	•	•	•	•	•	•	•	•	•	•	•	•
6	–	rm	Pipe, 4 x 1 DIN 73378, blue	890.31.054	•	•	•	•	•	•	•	•	•	•	•	•	•	•	•	•	•	•	•
		rm	Pipe, 4 x 1 VW TL 524 35-A, black	890.31.138	•	•	•	•	•	•	•	•	•	•	•	•	•	•	•	•	•	•	•
7	1	1	Adapter, Ø 7.5 / 3.5 mm	22.1000.20.3000	•	•	•	•	•	•	•	•	•	•	•	•	•	•	•	•	•	•	•
8	2	1	Hose clip, Ø 11 mm	10.2068.01.1098	•	•	•	•	•	•	•	•	•	•	•	•	•	•	•	•	•	•	•
9	1	1	Tank connection, d = 4 mm	22.1000.20.1600	•	•	•	•	•	•	•	•	•	•	•	•	•	•	•	•	•	•	•
10	1	1	Cable harness heater	25.2652.80.1100	•	•	•	•	•	•	•	•	•	•	•	•	•	•	•	•	•	•	•
(not ill.)	1	1	Cable harness heater Leisure (230 V)	25.2652.82.1100	•	•	•	•	•	•	•	•	•	•	•	•	•	•	•	•	•	•	•
11	1	1	Cable harness blower	22.1000.35.0100	•	•	•	•	•	•	•	•	•	•	•	•	•	•	•	•	•	•	•
12	1	1	Relay, 12 V	203.00.097	•	•	•	•	•	•	•	•	•	•	•	•	•	•	•	•	•	•	•
14	1	1	Bracket diagnostic connector, combi-clip	22.1000.51.4900	•	•	•	•	•	•	•	•	•	•	•	•	•	•	•	•	•	•	•
15	1	1	Fuse bracket, complete set	22.1000.31.0600	•	•	•	•	•	•	•	•	•	•	•	•	•	•	•	•	•	•	•
(not ill.)	1	1	Fuse link 5 A	204.00.007	•	•	•	•	•	•	•	•	•	•	•	•	•	•	•	•	•	•	•
	1	1	Fuse link 25 A	204.00.011	•	•	•	•	•	•	•	•	•	•	•	•	•	•	•	•	•	•	•
	1	1	Fuse link 20 A	204.00.010	•	•	•	•	•	•	•	•	•	•	•	•	•	•	•	•	•	•	•
16	1	1	Adapter di = 4.5 / 3.5 mm	25.2635.05.0007	•	•	•	•	•	•	•	•	•	•	•	•	•	•	•	•	•	•	•
17	1	1	Water pump, 12 V	25.2652.25.0000	•	•	•	•	•	•	•	•	•	•	•	•	•	•	•	•	•	•	•
18	1	1	Bracket water pump	22.1000.51.3900	•	•	•	•	•	•	•	•	•	•	•	•	•	•	•	•	•	•	•
19	1	1	Cable harness water pump, 12 V, L = 800 mm	25.2652.80.1500	•	•	•	•	•	•	•	•	•	•	•	•	•	•	•	•	•	•	•
20	–	1	Hose water, di = 20 mm	22.1000.10.0106	•	•	•	•	•	•	•	•	•	•	•	•	•	•	•	•	•	•	•
21	–	1	Hose clip, 20 – 32 mm	10.2067.02.0032	•	•	•	•	•	•	•	•	•	•	•	•	•	•	•	•	•	•	•
22	–	1	Spacer ring exhaust pipe, 21 / 44	22.1000.50.1002	•	•	•	•	•	•	•	•	•	•	•	•	•	•	•	•	•	•	•
23	1	1	Heater bracket	22.1000.51.4200	•	•	•	•	•	•	•	•	•	•	•	•	•	•	•	•	•	•	•
24	1	1	Screw M6x16, thread forming	25.2517.05.0006	•	•	•	•	•	•	•	•	•	•	•	•	•	•	•	•	•	•	•
25	–	1	Holder, straight, L = 135 mm	22.9000.50.9305	•	•	•	•	•	•	•	•	•	•	•	•	•	•	•	•	•	•	•
26	–	1	Holder, straight, L = 180 mm	22.9000.50.9306	•	•	•	•	•	•	•	•	•	•	•	•	•	•	•	•	•	•	•
27	3	1	Clamp	22.1000.51.4400	•	•	•	•	•	•	•	•	•	•	•	•	•	•	•	•	•	•	•

For unit

Item No.	Quantity per unit	Quantity per SU	Designation	Order No. (SU)	For unit											
					20.1963.05	20.1952.05	20.1993.05; 20.2048.05	20.1994.05; 20.2049.05	25.2694.05	25.2652.05	25.2912.05; 25.2971.05	25.2913.05; 25.2989.05	25.2921.05; 25.2990.05	25.2922.05; 25.2991.05	25.2984.05; 25.2996.05	
28	1	1	Combustion air intake silencer	22.1000.40.0013	•	•	•	•	•	•	•	•	•	•	•	•
29	1	1	Hose clip, 16 – 25 mm	10.2067.01.6025	•	•	•	•	•	•	•	•	•	•	•	•
30	1	1	Hose exhaust, di = 24 mm, L = 900 mm	360.61.274	•	•	•	•	•	•	•	•	•	•	•	•
31	1	1	Hose exhaust, di = 24 mm, L = 300 mm, with end sleeve	20.1731.80.0400	•	•	•	•	•	•	•	•	•	•	•	•
32	1	1	Exhaust silencer	22.1000.40.2100	•	•	•	•	•	•	•	•	•	•	•	•
33	1	1	Bracket exhaust silencer, Z shape	20.1533.88.0007	•	•	•	•	•	•	•	•	•	•	•	•
34	1	1	Bracket exhaust silencer, L shape	20.1348.03.0004	•	•	•	•	•	•	•	•	•	•	•	•
35	–	1	Clip, Ø 28 mm	152.09.010	•	•	•	•	•	•	•	•	•	•	•	•
36	1	1	Connector for metering pump	206.31.294	•	•	•	•	•	•	•	•	•	•	•	•
37	1	1	Pot-type strainer for metering pump	20.1312.00.0006	•	•	•	•	•	•	•	•	•	•	•	•

BUTLER TECHNİK

BUTLER TECHNIK

BUTLER TECHNIK

BUTLER TECHNİK

Eberspächer Climate Control
Systems GmbH & Co. KG
Eberspächerstraße 24
73730 Esslingen
Germany
info@eberspaecher.com
www.eberspaecher.com

