

INSTALLATION INSTRUCTIONS

EASYSTART PRO



**Control unit for
Eberspächer pre-heaters**

A WORLD OF COMFORT



Chapter Chapter title

Page Chapter contents

1 Introduction

1.1	Please read first	6
1.2	Special text formats and presentations	6
1.2.1	Lists	6
1.2.2	Cross references	6
1.3	Picture symbols	6
1.4	Repair	7
1.5	Disposal	7
1.6	Safety instructions	7
1.7	Intended use	7
1.8	Non-intended use	7
1.9	Disclaimer	8
1.10	Target groups for this document	8
1.11	Instruction obligation of the target groups	8
1.12	EU Declaration of Conformity	9
1.13	UKCA Declaration of Conformity	9
1.14	General information	10
1.14.1	Automatic operating time calculation	10
1.14.2	Ventilation operating mode	10
1.14.3	Installation instructions for special functions	10

2	Product information	
2.1	Technical data	11
2.2	Order No. EasyStart Pro	11
2.3	Scope of supply	11
2.3.1	Can be ordered as an optional extra	11
2.4	Sketch of scope of supply	12
2.5	Sketch of optional components	12
3	Installing EasyStart Pro	
3.1	EasyStart Pro installation sketch	13
3.2	Installation variants	14
3.2.1	Damage-free installation with self-adhesive foam underlay	14
3.2.2	Installation with self-adhesive foam underlay and one bore	15
3.2.3	Installation with bracket, with / without self-adhesive foam underlay	16
3.2.4	Installation with optional cover	16
3.3	EasyStart Pro connection to heater lead harness	17
3.4	Install optional temperature sensor	17
4	Getting to know EasyStart Pro	
4.1	Description of the operating components	18
4.2	The menus and their functions	19



5 Notes on operation and setting

5.1	Activating EasyStart Pro	20
5.2	Display	20
5.2.1	Display goes out	20
5.3	Activating a function	20
5.4	Setting the operating time	20
5.5	Operating modes	21
5.5.1	Heat	21
5.5.2	Ventilate	21
5.5.3	ADR mode	21
5.6	Temperature sensor	21
5.7	Further devices	22
5.8	Factory setting	22

6 Initial commissioning

6.1	Standard settings	22
6.2	Further settings	23
6.2.1	Determine display / control sensor	23
6.2.2	Define the temperature offset	23
6.2.3	Define the starting or departure time	24
6.2.4	Determine the maintenance interval	24

7 Workshop menu

7.1	Opening the vehicle workshop menu	24
7.2	Standard settings	25
7.2.1	Display language	25
7.2.2	Display	25
7.2.3	Reset to factory settings	26



7.3	Settings and information on the heater	26
7.3.1	Starting time / departure time	26
7.3.2	Control sensor (air heaters)	26
7.3.3	Display sensor (air and water heaters)	27
7.3.4	Hour counter	27
7.4	Information on EasyStart Pro	27
7.4.1	Version information	27
7.5	Maintenance and diagnostics	28
7.5.1	Set maintenance interval	28
7.5.2	Reading out the fault memory	29
7.6	Switch heater group	29
8	Fault diagnosis and remedy	
8.1	Heater error messages	31
8.2	Control unit error messages	33
9	Circuit diagram	
9.1	Connection to Airtronic 2 Hydronic S3 12Volt/24 Volt	34
10	Service	
10.1	Technical Support	35

1 Introduction

1.1 Please read first

Before you start with installation and configuration, always read through these installation instructions carefully.

These installation instructions contain important information that you need for installation and configuration.

Please keep these installation instructions in a safe place for future reference.

1.2 Special text formats and presentations

Special text formats and picture symbols are used in this document to emphasise different situations and subjects. Refer to the following examples for their meanings and appropriate action.

1.2.1 Lists

- This dot (•) indicates a list or action step, introduced by a heading.
 - If an indented dash (–) follows a “dot”, this list/action step is a sub-section/secondary step of the black dot.

1.2.2 Cross references

Underlined blue text denotes a cross-reference, which can be clicked in the PDF format. The part of the document named in the text is then displayed.

1.3 Picture symbols

Regulation!

This information indicates a statutory regulation. Any violation of these regulations results in expiry of the type-approval and the voiding of any guarantee and liability claims against Eberspächer Climate Control Systems GmbH.

Danger!

“Danger” indicates a situation that can directly result in death or serious injuries if not avoided.

→ This arrow indicates the appropriate measures to avert the imminent danger.

Warning!

“Warning” indicates a situation that can potentially result in death or serious injuries if not avoided.

→ This arrow indicates the appropriate measures to avert the potential danger.

Caution!

“Caution” indicates a situation that can potentially result in minor or slight injuries or damage to the device.

→ This arrow indicates the appropriate measures to avert the potential danger.

**Note**

This note contains recommendations for use and useful tips for the operation, installation and repair of the product.

1.4 Repair

Repair of the EasyStart Pro control unit is not permitted. Failure to comply makes the guarantee null and void and this leads to the exclusion of any liability of Eberspächer Climate Control Systems GmbH.

1.5 Disposal

Dispose of the product only according to the relevant legal regulations.

1.6 Safety instructions

**Danger!**

Always note and follow all information and notes, especially the safety instructions in this documentation and in the technical description of the heater.

- Risk of fire/deflagration due to ignition. Hazardous situations can occur if the heater is operated in the immediate vicinity of flammable gases, fumes, liquids or dust.
- Do not use the EasyStart Pro control unit if the heater to be activated is in an environment in which flammable gases, fumes, liquids, dust or other easily inflammable materials such as dry grass, leaves or paper are or could be present.

- Risk of poisoning due to escaping exhaust gases. Hazardous situations can occur during operation of the heater in enclosed rooms.
 - Do not use the EasyStart Pro control unit if the activated heater is located in enclosed rooms, e.g. in a garage or a multi-storey car park.
 - Risk of short-circuit due to penetrating liquid. Penetration of liquid into the receiver unit of the EasyStart Pro can result in dangerous situations.
 - To reduce the risk of an electrical short-circuit or damage, do not expose the receiver unit of the EasyStart Pro to moisture.
-

1.7 Intended use

The EasyStart Pro control unit is used to select the operating mode, to set the operating time, to preselect the switching on time and to switch On / Off a heater and / or add-on unit installed in the vehicle.

1.8 Non-intended use

- Use of the EasyStart Pro control unit for any purpose other than the intended use specified by the manufacturer is not permitted.
- Use the EasyStart Pro control unit only for its intended purpose.
- Do not use the EasyStart Pro control unit if a malfunction could cause a hazard and / or damage to property.
- Do not use the EasyStart Pro control unit if there is reason to assume that safe operation of the activated heater is no longer assured.

- Take all measures to prevent accidental putting back into service.

1.9 Disclaimer

The manufacturer is not liable for damage caused by improper use or incorrect operation. Failure to comply with the safety instructions makes the guarantee null and void and this leads to the exclusion of any liability of Eberspächer Climate Control Systems GmbH.

1.10 Target groups for this document

This document is aimed at the following target groups:

Specialist workshop

The “specialist workshop” target group includes all workshops trained by Eberspächer that purchase heaters or air conditioning systems and their control units, accessories and spare parts from Eberspächer or the trade and install, repair or service these on behalf of an end user.

Installation shop

The “installation shop” target group includes all companies trained by Eberspächer that purchase heaters or air conditioning systems and their control units, accessories and spare parts from Eberspächer and install, repair or service these on behalf of another company (normally the motor vehicle manufacturer / body builder).

End user

The “end user” target group includes all natural persons who operate a heater or air conditioner with the help of a control unit, regardless of whether they act as a consumer or as part of their job.

1.11 Instruction obligation of the target groups

Each of the above-mentioned target groups must unconditionally observe its instruction obligation. The instruction obligation includes the passing on of technical documents.

Technical documents are all documents published for the installation, operation, maintenance or repair of heaters or air conditioning systems and their control units, accessories and spare parts from Eberspächer.

Note

- Unless otherwise expressly stipulated below, the technical documents may be passed on in printed form, on a data medium or by Internet download.
- Current technical documents can be downloaded from the Eberspächer website.

Responsibility of the installation shop

The installation shop must pass on the following technical documents to the contracting company with the obligation to pass on these to the end user:

- Technical description
- Operating instructions

Responsibility of the specialist workshop

The specialist workshop must pass on the following technical documents to the end user, even if the order comes from a sub-contractor:

- Technical description
- Operating instructions



Note

The above-mentioned target groups must ensure that the end users are provided with the operating instructions on the product prepared by the manufacturer in printed form and in the end user's national language. If necessary this can be a short form of the detailed operating instructions, which are additionally enclosed with the product on a data carrier or are available to download from the internet.

1.12 EU Declaration of Conformity

We herewith declare that the control unit placed on the market by us conforms to the applicable provisions of the following EU Directive.

EU Directive 2014/30/EU



The full Declaration of Conformity can be viewed and downloaded from the download centre at www.eberspaecher.com.

1.13 UKCA Declaration of Conformity

We herewith declare that the version of the heater placed on the UK market by us conforms to the applicable provisions of the following UK Directives.

Electromagnetic Compatibility, Statutory Instrument 2016 No. 1091



The full Declaration of Conformity can be viewed and downloaded from the download centre at www.eberspaecher.com.

1.14 General information

1.14.1 Automatic operating time calculation

To use the **Automatic Operating Time Calculation** function of a water heater, the optionally available temperature sensor must be used.

Order No. of temperature sensor see page 11, installation see page 17.



Note

Automatic operating time calculation is not possible for air heaters.

1.14.2 Ventilation operating mode

In Ventilation mode, the heater fan of water heaters is actuated directly, bypassing heating mode. If the  symbol is not displayed, the **Ventilation** function is not available for the heater.

1.14.3 Installation instructions for special functions

These installation instructions describe the standard configuration. For enhanced configuration of the EasyStart Pro and for special functions, e.g. combinations with different EasyStart control units, installation in ADR vehicles, operating the heater and additional unit, etc. refer to the Installation Instructions Plus “Special Functions and Diagnosis”: these can be viewed and downloaded from the Eberspächer Service portal.

2 Product information

2.1 Technical data

	EasyStart Pro
Operating voltage	12 volt / 24 volt
Dimensions	W : 82 mm, H: 37 mm, D: 19 mm
allowable ambient temperature	- 40 °C to +85 °C
LCD ambient temperature	The display becomes sluggish at temperatures below -10°C, i.e. the flashing sequence of the symbols is somewhat slower. The contrast becomes weaker above +70°C.

2.2 Order No. EasyStart Pro

EasyStart Pro 12 / 24 Volt	22.1000.35.2200
----------------------------	-----------------

2.3 Scope of supply

Sketch see page 12.

Figure No.	Quantity	Designation
1	1	EasyStart Pro 12 / 24 Volt
2	1	Bracket
3	1	Foam underlay, self-adhesive on both sides
4		Bush housing, 4-pin (mounted)
5		Connector housing, 4 pin (fitted)
6		Connector housing, 3-pin (mounted, temperature sensor connection)
7		Bush housing, 3-pin (in the bag)
8	1	Self-tapping screws (in bag)
9	1	Drilling template, self-adhesive
10	1	Quick-start guide
11	1	CD-ROM

2.3.1 Can be ordered as an optional extra

Sketch of optional components see page 12.

Figure No.	Quantity	Designation	Order No.
12	1	Temperature sensor	22.1000.34.5400
13	1	Cover	22.1000.51.4100

2.4 Sketch of scope of supply

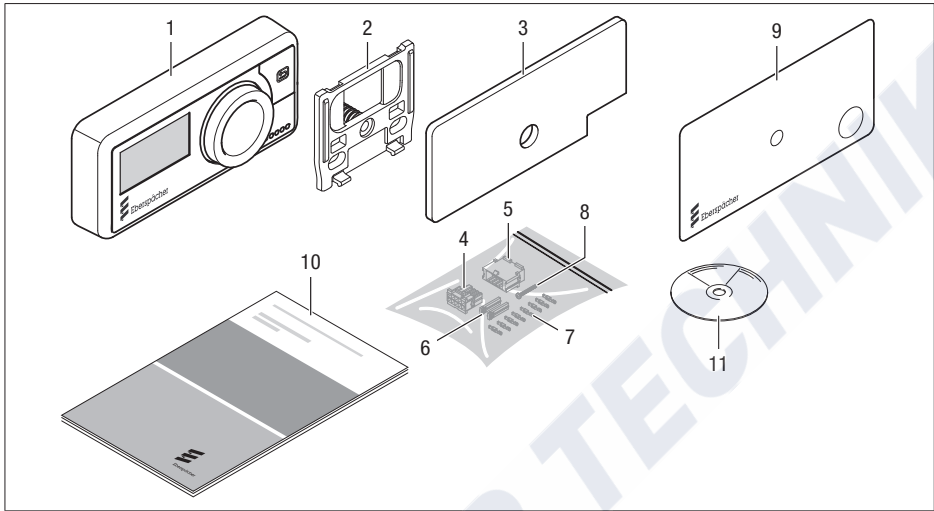

Key see page 11

2.5 Sketch of optional components

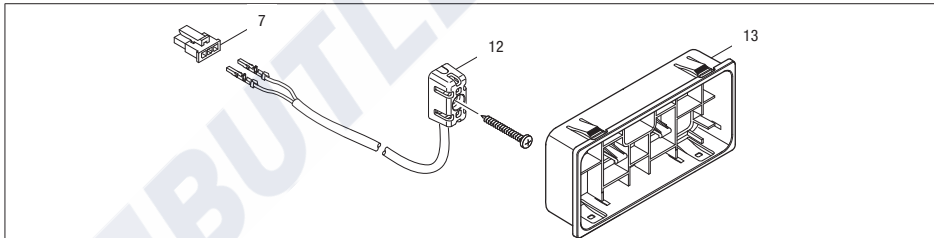

Key see page 11



Note

- An additional temperature sensor is not absolutely essential with air heaters. The temperature sensor that is installed in the heater and controls the temperature inside the vehicle is also used for the EasyStart Pro temperature display.

3 Installing EasyStart Pro

3.1 EasyStart Pro installation sketch

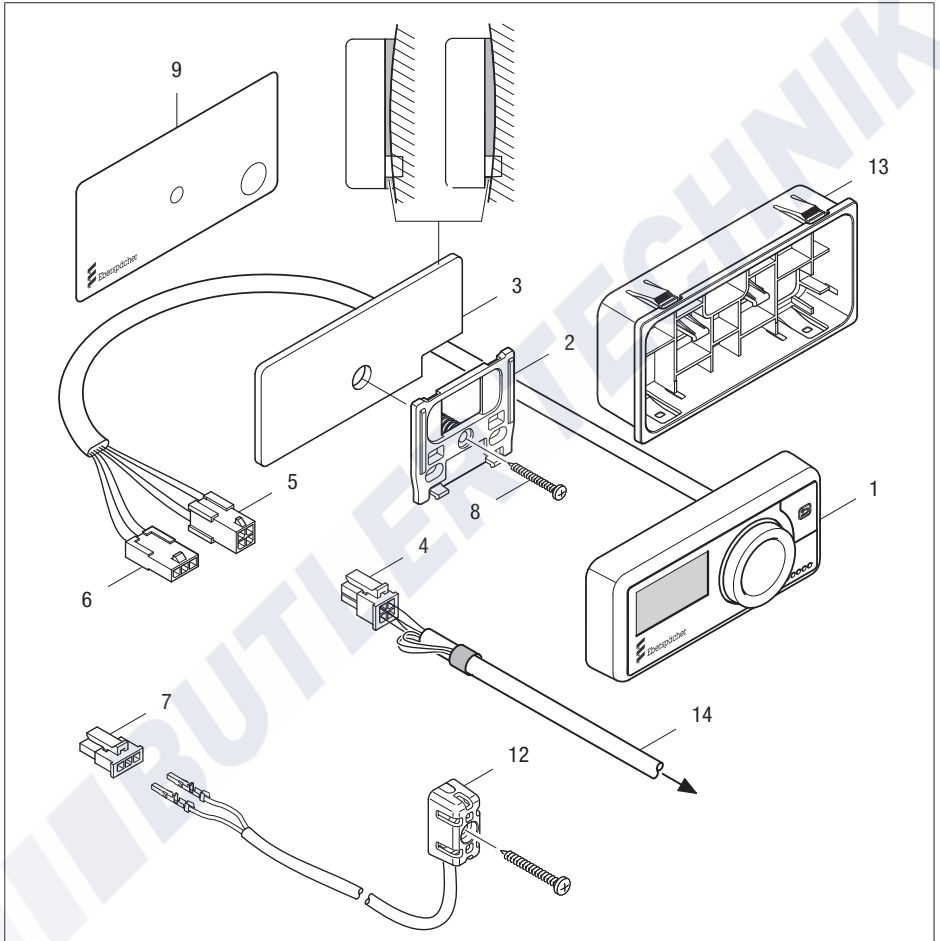

Key see page 11

3.2 Installation variants

EasyStart Pro can be installed with the parts in the scope of supply in three ways. The optional cover allows a fourth installation method.

1. Damage-free installation with the self-adhesive foam underlay on the dashboard. The connecting lead remains visible.
2. Installation with the self-adhesive foam underlay and one bore in the dashboard. The connecting lead is invisible.
3. Installation with bracket, with or without self-adhesive foam underlay. Two bores are necessary for the bracket and the cable leadthrough.
4. Installation with optional cover. A cut-out has to be prepared in the dashboard for installation of the cover. Details of the dimensions of the cut-out and the permissible wall thickness, see page 16.

Caution!

Damage to concealed components.

When drilling the connection and mounting bores or when preparing the cut-out for the cover in the dashboard, take care not to damage concealed parts behind the dashboard.

- Check that the space behind the installation area is free from components.

Note

- Install EasyStart Pro only inside the vehicle.
- Do not insert the control unit 5 A fuse into the fuse holder until all work has been completed.

Install EasyStart Pro in a suitable place on the dashboard, within the driver's view and connect as shown in the sketch on page 13 and the circuit diagram from page 34.

3.2.1 Damage-free installation with self-adhesive foam underlay

No bores or cut-outs have to be made in the dashboard for installation of EasyStart Pro. Therefore create an opening for the installation on the rear of the device, under the connecting lead, by breaking out the housing part in the frame.

Caution!

Risk of damage to the device when breaking out the housing section.

Use pliers to break out the housing section and always break out the frame tab upwards towards the device rear panel.

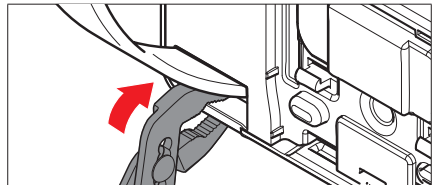

- Installation location and device rear panel must be free from dust and grease. Clean both using a suitable cleaning agent.

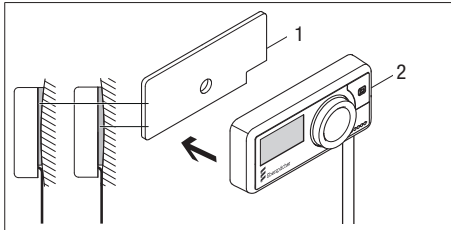

- Foam underlay
- EasyStart Pro

- Peel off the protective film from the rear of the foam underlay and attach the underlay at the installation location.
- Peel off the protective film from the front of the foam underlay.
- Press the connecting lead into the opening in the housing and route downwards.
- Attach EasyStart Pro flush with the foam underlay.
- Route the connecting lead to the heater wiring harness and connect.

3.2.2 Installation with self-adhesive foam underlay and one bore

A bore of 12 mm diameter has to be drilled in the dashboard for installation of EasyStart Pro.

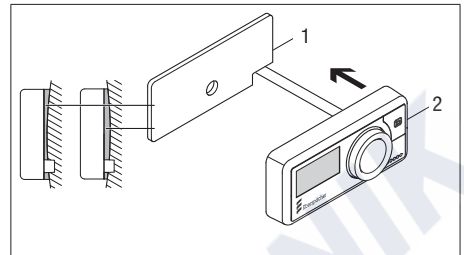

- Foam underlay
- EasyStart Pro

- Use the self-adhesive drilling template supplied to position and drill the 12 mm diameter bore.
- Drill the 12 mm diameter bore, remove the drilling template and deburr the bore.
- Installation location and device rear panel must be free from dust and grease. Clean both using a suitable cleaning agent.
- Peel off the protective film from the rear of the foam underlay and attach the underlay at the installation location.

i Note

The bore in the dashboard is located in the cut-out of the foam underlay.

- Peel off the protective film from the front of the foam underlay.
- Route the connecting leads through the bore and attach EasyStart Pro flush with the foam underlay.
- Route the connecting lead to the heater wiring harness and connect.

3.2.3 Installation with bracket, with / without self-adhesive foam underlay

Two bores have to be drilled in the dashboard for installation of EasyStart Pro.

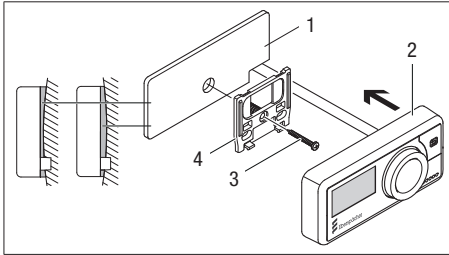

- 1 Foam underlay
- 2 EasyStart Pro
- 3 Retaining screw
- 4 Bracket

- Use the self-adhesive drilling template supplied to position the device and drill the two holes \varnothing 6 mm and \varnothing 12 mm.

i Note

After drilling the holes, remove the drilling template.

- Deburr the holes.
- The foam underlay can be used if necessary to level out unevenness. To do this, peel off the protective film from the rear and attach the foam underlay at the cleaned installation location.
- Insert the bracket with expansion plug into the \varnothing 6 mm bore.
- Align the bracket, press onto the foam underlay and secure with the retaining screw in the expansion plug.
- Route the connecting leads of the EasyStart Pro through the \varnothing 12 mm bore.

- Clip EasyStart Pro into the bracket.
- Route the connecting leads to the heater wiring harness and connect.

3.2.4 Installation with optional cover

Order No.: 22.1000.51.4100

If an existing control unit is replaced with the EasyStart Pro, it may be necessary to use the optional cover for installation of the EasyStart Pro. The cover is installed without fixings by clipping it into a cut-out in the dashboard.

i Note

The bracket, retaining screw, foam underlay and drilling template supplied with the EasyStart Pro are not needed for installation with cover.

- If one does not already exist, cut out a rectangle (W=84.5 mm, H=40 mm) in the dashboard.

i Note

Observe the permissible wall thickness, see sketch.

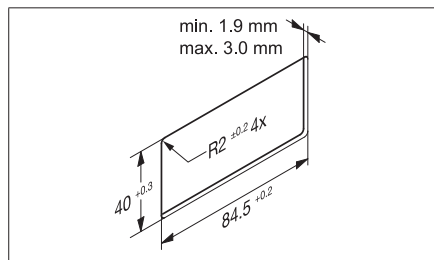

- Insert the cover into the dashboard until it stops.
The rectangular opening (1) for the EasyStart Pro connecting leads must be in the bottom right-hand corner.

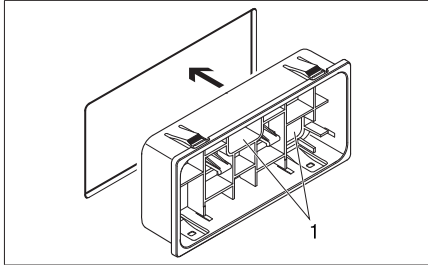

1 Cable leadthrough

- Route the connecting leads through the opening.
- Place EasyStart Pro into the cover and push in until the control unit engages in the retaining clips (1).

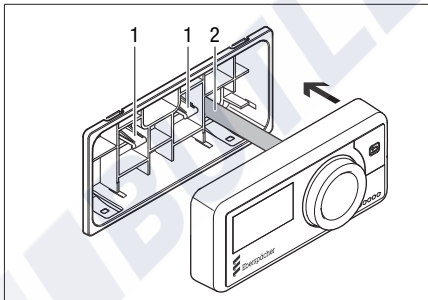

1 Retaining clips

2 Connecting lead

- Route the connecting leads to the heater wiring harness and connect.

3.3 EasyStart Pro connection to heater lead harness

Connect 4-pin connector housing -XS1 of the EasyStart Pro lead harness to 4-pin bush housing -XB1 of the heater lead harness (14).

3.4 Install optional temperature sensor

- Use the screw provided to fasten the temperature sensor inside the vehicle so that it measures the representative interior temperature.
- Recommendation: Install the temperature sensor in the centre console at the level of the seats.
- Connect 3-pin connector of the room temperature sensor wiring harness to the 3-pin bush housing of the EasyStart Pro wiring harness.



Note

- Do not position the temperature sensor in an area in which is exposed to direct sunlight, near the outlet vents of the vehicle or in the footwell.
- Circuit diagram see page 34.

4 Getting to know EasyStart Pro

EasyStart Pro has a simple operating structure. All settings, functions and parameters are controlled with a single operating button.

4.1 Description of the operating components

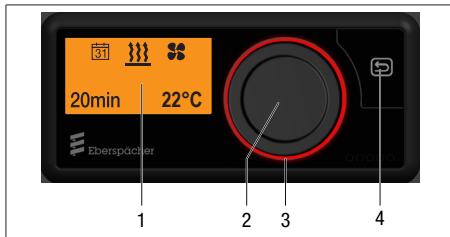

1 Display

The display shows the following parameters:

- Current operating mode
- Current interior temperature
- Operating mode
- Timer positions
- Settings
- Error codes

2 Operating button

- The operating button is used to operate, select and program all the functions and values in EasyStart Pro. The operating button can be turned and pressed.
 - Turning selects a value/function within a menu.
 - Turning to the right increases a value or selects the next menu item to the right.
 - Turning to the left decreases a value or selects the next menu item to the left.

- Pressing confirms the flashing menu item or value on the display.
- If EasyStart Pro is in sleep mode (display OFF), pressing or turning “wakes up” the active mode. If the heater is switched off, the Start mask is displayed. If the operator makes no inputs, an overview mask is displayed before the system goes to sleep mode.
- When the heater is running, the last mask is displayed.

i Note

- A LONGPRESS (min. 2 sec.) immediately starts all connected heaters. The standard operating time here is set at the factory to 30 minutes.
- During operation, a LONGPRESS (min. 2 sec.) immediately switches off all connected heaters.
- If terminal 58 has voltage, sleep mode will not be activated.

3 LED ring

- The LED ring with its different colours serves to indicate the operating mode.
 - Red ring: Heating mode
 - Blue ring: Ventilator mode
 - Orange ring: Residual heat mode
 - White ring: System configuration
 - Red flashing ring: Fault in one of the connected heaters or in EasyStart Pro

4 Button BACK





- The BACK button causes a jump back to the menu or command at the next higher level.
- If EasyStart Pro is in sleep mode (display OFF), pressing “wakes up” the live mode again.
 - If all heaters are switched off, the Start mask will be displayed.
 - If a heater is running, the last mask is displayed.

4.2 The menus and their functions





Menu bar

The following menus can be selected from the menu bar (turn the operating button to the right):

Symbol	Menu
	Heat
	Ventilate
	Residual heat
	Settings
	Timer

Note

- The Ventilation  function is only displayed if the heater supports this function.
- The timer function  is not available on vehicles in ADR mode.

Status area

When the menu (heat, ventilate, settings, timer or residual heat) is activated, various items of information are display in the status area. These are presented and described in the respective sections of these operating instructions.

Input area



Display:

e.g. Heating ON / Operating time 107 min.

In the input area, the symbol of the selected menu item appears in the middle of the display. The corresponding setting value flashes in the input area and can be altered with the operating button by turning and confirmed by pressing.

5 Notes on operation and setting

5.1 Activating EasyStart Pro

If the display is not lit, EasyStart Pro has to be activated. Pressing the operating button or BACK button  displays the Start mask; you can then continue with operation or setting.

5.2 Display

The display is lit

- During operation of EasyStart Pro
- When terminal 58 has voltage, for example when the vehicle lights are switched on (optional).
- When the heater is ON (the display goes out after approx. 30 seconds).

5.2.1 Display goes out

The display goes out after approx. 30 seconds if

- No settings are made.
- No heater is switched on.
- When using terminal 58, when the vehicle lights are switched off.

EasyStart Pro then goes to sleep mode.

EasyStart Pro then has to be activated (see above) before a new input can be made.

5.3 Activating a function

The symbol of the function to be activated appears in the middle and flashing in the display.

Flashing function / flashing value

- Select the flashing function in the menu bar by pressing the operating button.
- Increase or decrease the flashing value by turning the operating button. Then confirm the selected value by pressing the operating button.

Cancel / exit settings

Every setting can be cancelled or exited by pressing the BACK button .

Note

Settings and changes must always be confirmed by pressing the operating button, otherwise they will be lost.

5.4 Setting the operating time

The operating time can be set individually using the operating button.

- Turning to the right increases the operating time.
- Turning to the left decreases the operating time.
- Setting range for the operating time: min. 10 minutes to max. 120 minutes in one-minute steps.
- The operating time can be prolonged to 720 minutes. Above the 120th minute, the input is made in 60-minute steps. To do this, please contact the installation workshop.

Note

- Continuous heating mode is additionally possible for air heaters.
- The operating times of all connected heaters can be set independently of one another.

5.5 Operating modes

5.5.1 Heat

In this operating mode, the heater heats the vehicle engine via the coolant circuit and the vehicle interior via the ventilation louvres, irrespective of the configuration.

5.5.2 Ventilate

In this operating mode, the heater supplies the vehicle interior with fresh outdoor air via the ventilation louvres. This operating mode is only possible if the function is supported by the heater version (see also Technical Description of the Heater).

5.5.3 ADR mode

ADR mode is reserved for vehicles transporting hazardous goods on the road (e.g. road tankers).

Note

- ADR function in EasyStart Pro must be activated via EasyScan.
- The timer function is not available in ADR mode.

Air heater

- All operating modes are possible.
- Condition: the ADR button connected with the heater also has to be pressed (button on request).

Water heater

- Heating mode and residual heat possible.
- Condition: the ADR button connected with the heater also has to be pressed (button on

request).

- Ventilating is not possible.

Steps for ADR mode

- On switching the heater on, the following instruction appears in the display:

ADR locked

Push ADR Button

- Press ADR button within 20 seconds to eliminate the interlock and start the heater.

Note

Press and hold the ADR button until the EasyStart Pro display says the heater has been activated (approx. 2 sec.).

- Heater starts with normal mode.
- If the ADR button is not pressed within 20 seconds, the following instruction appears in the display:

ADR Button
not pushed

- Repeat.

5.6 Temperature sensor

EasyStart Pro has an integrated temperature sensor that measures the vehicle interior temperature. During installation, an additional external temperature sensor can be connected and integrated into the system.

With air heaters, the temperature sensor installed in the heater for control of the heater

can also be used to measure the vehicle interior temperature. This will be configured by the installing workshop during initial commissioning.

5.7 Further devices

EasyStart Pro allows the simultaneous operation of up to 4 heaters or, for example, also a stationary air conditioner. It is also possible to combine a heater with a fan. The fan is then used to circulate the air inside the vehicle. All connected systems can be operated simultaneously or independently of one another.

Note

The number of symbols and displays differs depending on the installed heater and feature options.

5.8 Factory setting

Timer mode (for all heaters)

- Weekday group: Mon – Fri
- Departure time: 07:00 h

Air heaters

- Operating time: 30 minutes
- Target temperature: 22°C / 72°F

Water heaters

- Operating time: 30 minutes
- Max. operating time: 60 minutes

6 Initial commissioning

The system must be configured according to its use. These installation instructions describe the standard configuration during initial commissioning. For details of enhanced configuration of EasyStart Pro and special functions, you can view and download the “Special Functions and Diagnosis” installation instructions from the Eberspächer partner portal <https://partner.eberspaecher.com>.

6.1 Standard settings

- Select the desired display language by turning the operating button and confirm by pressing.



Setting the time format

- Select between 12 h and 24 h format by turning the operating button and confirm by pressing.

Setting the time:

- Select the hours by turning the operating button and confirm by pressing.
- Select the minutes by turning the operating button and confirm by pressing.

Setting the weekday

- Select the weekday by turning the operating button and confirm by pressing.

°C/F Setting the temperature format

- Select between degrees Celsius and degrees Fahrenheit by turning the operating button and confirm by pressing.

6.2 Further settings

6.2.1 Determine display / control sensor

During initial commissioning, EasyStart Pro asks whether an external temperature display sensor or control sensor is to be determined.

i **Note**

An external temperature display sensor is available as an option. For installation and connection to EasyStart Pro see page 17.

- For **water heaters**: Temperature display sensor

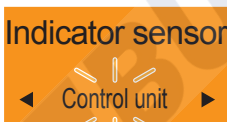

- For **air heaters**: Control sensor and temperature display sensor

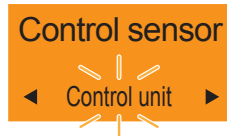

- Select by turning the operating button and confirm by pressing.

i **Note**

If several heaters are connected in heater groups, please see the note on heater identification in chapter “Switch heater group” on page 29.

6.2.2 Define the temperature offset

If the temperature display sensor of the control unit or heater (with air heaters) is defined as display sensor, the temperature offset of the display sensor can be defined in the next step.

- Select the temperature offset by turning the operating button and confirm by pressing.



The temperature offset can be set in the following ranges:

- -5°C to $+5^{\circ}\text{C}$ in 1°C increments
- -10°F to $+10^{\circ}\text{F}$ in 1°F increments

6.2.3 Define the starting or departure time

Users of EasyStart Pro can choose between starting time and departure time during operation of the controlled heater.

Select between [Starting time] and [Departure time] by turning the operating button and confirm by pressing.



Note

- If [Departure time] was selected, the engine displacement must be selected and confirmed in the next step.
- If several heaters are connected in heater groups, please see the note on heater identification in chapter “Switch heater group” on page 29.

7 Workshop menu

The workshop menu offers the following setting possibilities:

- Configuration change for the operation of EasyStart Pro
- Function modification (display, maintenance, reset to factory settings, etc.)
- Device info on EasyStart Pro (hardware and software version)
- Read out and delete heater and control unit

6.2.4 Determine the maintenance interval

In the next step, EasyStart Pro asks for the maintenance interval for the heater.

If desired, set the interval in hours by turning the operating button and confirm by pressing. Otherwise select [OFF] and confirm by pressing.

- 10 h to 1000 h: 10 h increments
- 1000 h to 5000 h: 500 h increments



When the maintenance interval has been defined, initial commissioning has been completed. EasyStart Pro boots on the basis of the inputs previously made. The Start mask is then displayed.





Note

If errors in the configuration are discovered after initial commissioning, the fuse must be removed to reset the system to the delivery condition.

fault memory

7.1 Opening the vehicle workshop menu

To open the workshop menu, select the Settings  menu and then hold the BACK button  pressed for longer than 2 seconds while the clock symbol under the gear wheel is flashing.



7.2 Standard settings

7.2.1 Display language

The [Language] menu defines the display language.



- Confirm the menu by pressing the operating button.
- Select the desired language by turning the operating button.
- Confirm the selection by pressing the operating button.

7.2.2 Display

The [Display] defines the contrast and brightness of the display.



- Confirm the menu by pressing the operating button.

Brightness



- Select the menu by turning the operating button.
- Confirm the selection by pressing the operating button.
- Select the desired brightness by turning the operating button.

i Note

Selection of the brightness between 1% and 100% in 1% increments.

- Confirm the selection by pressing the operating button.

Contrast

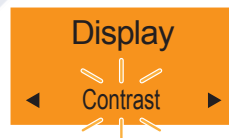

- Select the menu by turning the operating button.
- Confirm the selection by pressing the operating button.
- Select the desired contrast by turning the operating button.

i Note

Selection of the contrast between 30% and 70% in 1% increments.

7.2.3 Reset to factory settings

The [Factory reset] menu resets all the settings of EasyStart Pro to the delivery condition.



- Confirm the menu by pressing the operating button.
- Select [Yes] or [No].
- Confirm the selection by pressing the operating button.

7.3 Settings and information on the heater

7.3.1 Starting time / departure time

The settings for starting time or departure time for time mode of EasyStart Pro are made in the [Start/departure] menu.

- If starting time is selected, the controlled heater (or heater group) starts at the starting time programmed in the timer.
- If starting time is selected, the controlled heater (or heater group) starts on the selected day before reaching the set departure time so that engine and vehicle interior are heated up in good time. This takes place in line with parameters such as current temperature, preselected operating time and engine displacement.



- Confirm the menu by pressing the operating button.
- Select [Starting time] or [Departure time].
- Confirm the selection by pressing the operating button.

Note

- If [Departure time] is selected, additional parameters have to be entered:
 - Engine displacement (1000 cc – 4000 cc)
 - Maximum operating time of the heater (10 minutes – 60 minutes).
- If the heater is connected to the vehicle battery (e.g. car battery), the operating time of the heater should not exceed the subsequent driving time of the vehicle. This will ensure that the vehicle battery is sufficiently charged.

Example:

Operating time of the heater: 25 minutes
 Driving time of the vehicle: min. 25 minutes

- If several heaters are connected in heater groups, please see the note on heater identification in chapter "Switch heater group" on page 29.

7.3.2 Control sensor (air heaters)

The [Control sensor] menu defines which temperature sensor is to be used as control sensor for the air heater.



- Confirm the menu by pressing the operating button.

- Select [Control unit] or [Air heater].
- Confirm the selection by pressing the operating button.

7.3.3 Display sensor (air and water heaters)

The [Display sensor] menu defines whether an external temperature sensor is to be used as display sensor.



- Confirm the menu by pressing the operating button.
- **For water heaters**
 - Select [None] if no display sensor is required.
 - Select [Control unit] if the temperature sensor in the control unit is to be used as display sensor.
- **For air heaters**
 - Select [None] if no display sensor is required.
 - Select [Control unit] if the temperature sensor in the control unit is to be used as display sensor.
 - Select [Air heater] if the temperature sensor in the air heater is to be used as display sensor.
- Confirm the selection by pressing the operating button.

Note

- If [Control unit] is selected as display sensor, the desired temperature offset must then be selected. The temperature offset can be selected in the range from -5°C to $+5^{\circ}\text{C}$.

- If several air heaters are connected in heater groups, please see the note on heater identification in chapter “Switch heater group” on page 29.

7.3.4 Hour counter

The [Hour counter] menu displays the actual operating hours of all the connected heaters.



- Confirm the menu by pressing the operating button.
- Read out the number of operating hours.

Note

If several heaters are connected, the operating hours of each heater are displayed individually.

- Go back by pressing the operating button or BACK button.

7.4 Information on EasyStart Pro

7.4.1 Version information

The [Version] menu reads out information on the hardware and software of EasyStart Pro.



- Confirm the menu by pressing the operating button.
- Read out information on the following parameters by turning the operating button:
 - [ID]: ID number of this device
 - [BootSW]: Boot software version on this device
 - [SW]: Software version on this device
 - [HW]: Hardware version of this device
 - [ResVer]: Resource version of this device
- Go back by pressing the BACK button.

7.5 Maintenance and diagnostics

7.5.1 Set maintenance interval

The [Maint. interval] defines the intervals at which EasyStart Pro should be serviced. In addition, the current status of the maintenance interval can be read out or reset.



- Confirm the menu by pressing the operating button.

Set maintenance interval

- Select between [ON] and [OFF].
- Confirm the selection by pressing the operating button.
- If [ON] is selected, select the maintenance interval in h and confirm.

Note

Selection of the maintenance interval:

- Between 10 h and 1000 h in 10 h increments
- Between 1000 h and 5000 h in 500 h increments

Read out status of the maintenance interval

- Confirm the menu by pressing the operating button.
- Select [Status] by turning the operating button and confirm by pressing.
- The current status of the maintenance interval is displayed, e.g.



- Go back by pressing the BACK button.

Reset the maintenance interval after carrying out maintenance

- Confirm the menu by pressing the operating button.
- Select [Reset] by turning the operating button and confirm by pressing.
- The maintenance interval is reset to 0 and starts again.

7.5.2 Reading out the fault memory

Fault messages from EasyStart Pro and all connected heaters are stored in the [Fault messages] menu. They can be read out and deleted after remedying the respective fault.



- Confirm the menu by pressing the operating button.
- Select [Control unit] or [Heater] by turning the operating button.

Note

If several heaters are connected, they are displayed in turn. The fault messages for each heater can be displayed and read out in turn by turning and pressing the operating button.

- Confirm the selection by pressing the operating button.
- Select [Read] by turning the operating button and confirm by pressing.
- Read out the fault message and remedy the fault. Fault diagnostics, see from page 31.
- Then select [Delete] by turning the operating button.
- Delete the fault list by pressing the operating button.

7.6 Switch heater group

The [Swap] menu allows the heater groups 1 and 2 configured during initial commissioning to be switched.



- Confirm the menu by pressing the operating button.
- Then select [Yes] by turning the operating button.
- Confirm the selection by pressing the operating button.

Note

The [Identification] menu allows connected heaters to be unambiguously assigned to heater group 1 or heater group 2:

- Confirm the [Swap] menu by pressing the operating button.
- Select [Identification] by turning the operating button.



- Confirm the selection by pressing the operating button.
- Select between [Group 1] and [Group 2] by turning the operating button.

Identification







- Confirm the selection by pressing the operating button.
- Select between [ON] and [OFF] by turning the operating button.







- Confirm the selection by pressing the operating button.
 - If [ON] is selected, the fan of each of the heaters connected in the respective group starts. This allows a clear allocation to this heater group.
 - Confirmation of [OFF] terminates the identification of the heaters connected in the respective group at the end of the fan function.
-

8 Fault diagnosis and remedy

8.1 Heater error messages

Display	Description	Remedy / Customer
 Service	<ul style="list-style-type: none"> There is a fault in the heater that can only be remedied by a specialist workshop. 	<ul style="list-style-type: none"> Visit an authorised Eberspächer workshop.
 Undervoltage	<ul style="list-style-type: none"> Undervoltage applied at the heater control box without interruption for at least 20 seconds. 	<ul style="list-style-type: none"> Check battery for a drop in voltage. Charge battery or replace, if necessary.
 Overvoltage	<ul style="list-style-type: none"> Overvoltage applied at the heater control box without interruption for at least 20 seconds. 	<ul style="list-style-type: none"> Check battery and replace, if necessary.
 Fuel Supply or Pump	<ul style="list-style-type: none"> Fault in the fuel supply or fuel pump. 	<ul style="list-style-type: none"> Check cables for continuity, short circuit and damage. Pull the plug off the metering pump and inspect for damage. Check the fuel level in the fuel tank. If the fault cannot be remedied, please contact Eberspächer Support.
 Water Circuit or Pump	<ul style="list-style-type: none"> With water heaters only: Water temperature in the heater too high. 	<ul style="list-style-type: none"> Check the water pump for proper function. Check the water circulation in the water circuit. The heater can be reset to the delivery condition by removing the heater fuse. If the fault cannot be remedied, please contact Eberspächer Support.

Display	Description	Remedy / Customer
 Air Ducting or Outlet	<ul style="list-style-type: none"> With air heaters only: Air temperature in the heater too high. 	<ul style="list-style-type: none"> Check the air lines. Are air lines clogged or kinked? Air all air louvres free? The heater can be reset to the delivery condition by removing the heater fuse. If the fault cannot be remedied, please contact Eberspächer Support.
 Overheat. Heater locked.	<ul style="list-style-type: none"> Overheating of the heater detected. The heater is interlocked for safety reasons. 	<ul style="list-style-type: none"> The heater can be reset to the delivery condition by removing the heater fuse. If the fault cannot be remedied, please contact Eberspächer Support.
 Restricted Operation	<ul style="list-style-type: none"> Emergency running of the heater. 	<ul style="list-style-type: none"> There is a fault in the heater. Restricted operation is still possible, however (with air heaters with target temperature 20°C). If the fault cannot be remedied, please contact Eberspächer Support.
 ADR locked	<ul style="list-style-type: none"> Interlock of the heater in ADR vehicles <ul style="list-style-type: none"> – when starting the PTO – on turning the vehicle engine off 	<ul style="list-style-type: none"> Eliminate reason for interlock. Check heater wiring using the ADR circuit diagram. If the fault cannot be remedied, please contact Eberspächer Support.
<p>i Note The heater must be switched off when the PTO is activated and on turning the vehicle engine off.</p>		

8.2 Control unit error messages

Display	Description	Remedy / Customer
<p>◀ 1 ▶</p> <p>Ext. Temp. Sensor defective</p>	<ul style="list-style-type: none"> The external temperature sensor is defective. 	<ul style="list-style-type: none"> Check the wiring of the external temperature sensor for continuity, short-circuit or damage; replace the temperature sensor, if necessary. If the fault cannot be remedied, please contact Eberspächer Support.
<p>◀ 2 ▶</p> <p>Int. Temp. Sensor defective</p>	<ul style="list-style-type: none"> The internal temperature sensor is defective. 	<ul style="list-style-type: none"> There is no remedy for this fault. The control unit has to be replaced.
<p>◀ 3 ▶</p> <p>Rotary Knob jammed</p>	<ul style="list-style-type: none"> The operating button is blocked. 	<ul style="list-style-type: none"> Can the operating button be freed again by hand? If the fault cannot be remedied, please contact Eberspächer Support.
<p>◀ 4 ▶</p> <p>Pushbutton jammed</p>	<ul style="list-style-type: none"> The button is blocked. 	<ul style="list-style-type: none"> Can the button be freed again by hand? If the fault cannot be remedied, please contact Eberspächer Support.
<p>◀ 6 ▶</p> <p>Missing Data</p>	<ul style="list-style-type: none"> Data are missing for EasyStart Pro for initial commissioning. 	<ul style="list-style-type: none"> Disconnect EasyStart Pro from the power supply and connect again. If the fault cannot be remedied, please contact Eberspächer Support.
<p>◀ 7 ▶</p> <p>Timer mode not allowed</p>	<ul style="list-style-type: none"> Timer mode is not permitted during ADR mode. 	<ul style="list-style-type: none"> Terminate ADR mode and test timer mode again. If the fault cannot be remedied, please contact Eberspächer Support.
<p>◀ 8 ▶</p> <p>Operation not supported</p>	<ul style="list-style-type: none"> The heater is in auxiliary heating mode via Switching Plus and cannot be operated via EasyStart Pro during this time. 	<ul style="list-style-type: none"> Terminate auxiliary heating mode via Switching Plus.
<p>◀ 9 ▶</p> <p>CAN communication error</p>	<ul style="list-style-type: none"> Communication error on the CAN bus link. 	<ul style="list-style-type: none"> Inspect the wiring for cable breakages/short-circuits. If the fault cannot be remedied, please contact Eberspächer Support.

9 Circuit diagram

9.1 Connection to Airtronic 2 | Hydronic S3 12Volt/24 Volt

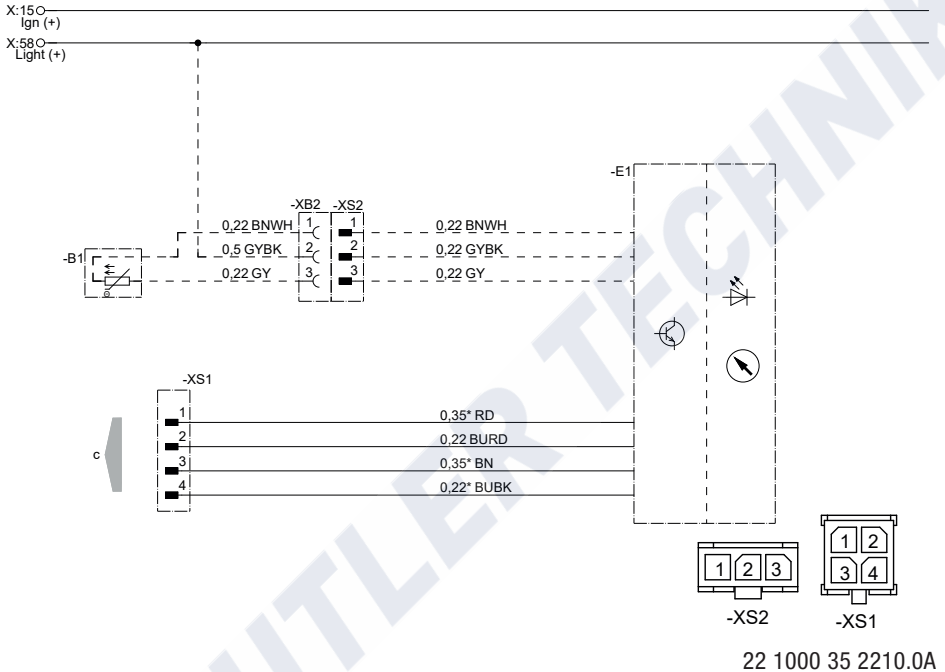

- E1 EasyStart Pro timer
- B1 Temperature sensor (optional)
- c to the heater

Cable colours

RD	red	GY	grey	BK	black
BU	blue	YE	yellow	GN	green
WH	white	VT	violet	BN	brown

10 Service

10.1 Technical Support

If you have any technical questions or problems with the heater, the control unit or the operating software, please contact the following service address:

support-UK@eberspaecher.com

In Canada please contact:

support-CA@eberspaecher.com

In the United States of America please contact:

support-US@eberspaecher.com



BUTLER TECHNIK

/// BUTLER TECHNIK

/// BUTLER TECHNIK

/// BUTLER TECHNIK

**Eberspächer Climate
Control Systems GmbH**

Eberspächerstraße 24

73730 Esslingen

Germany

info@eberspaecher.com

www.eberspaecher.com

Eberspacher (UK) Ltd.

Climate House, Yeoman Road

Ringwood, Hampshire BH24 3FA

United Kingdom

enquiries@eberspacher.com

www.eberspaecher.co.uk



Eberspächer