



# VW T5 Airtronic D2 12V Heater Kit

Part No.E6175

## Installation Instructions

(Use with technical description and instruction manual)

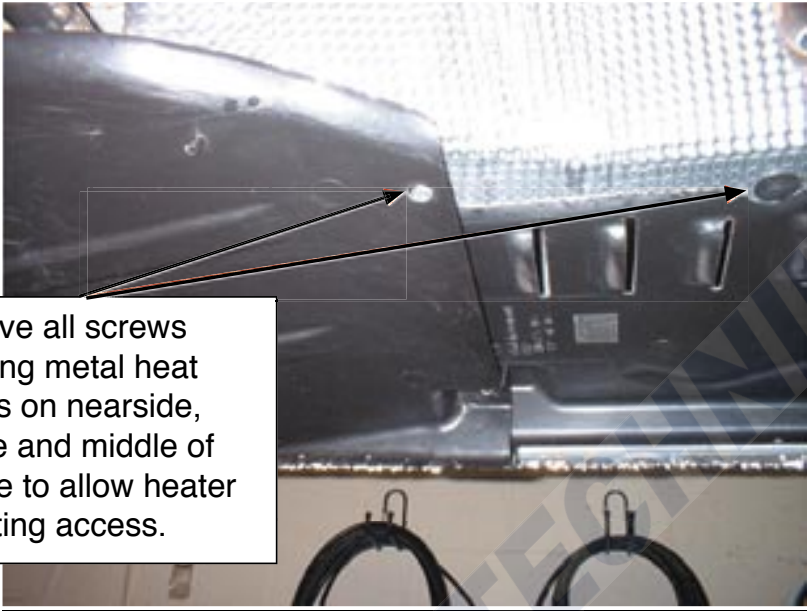

Remove all screws securing metal heat guards on nearside, offside and middle of vehicle to allow heater mounting access.

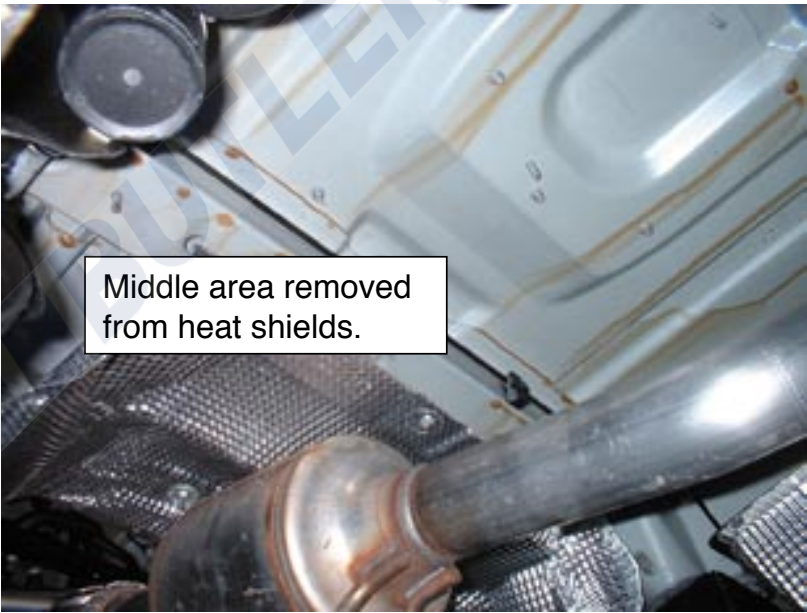

Middle area removed from heat shields.

Nearside area removed for mounting of fuel system.



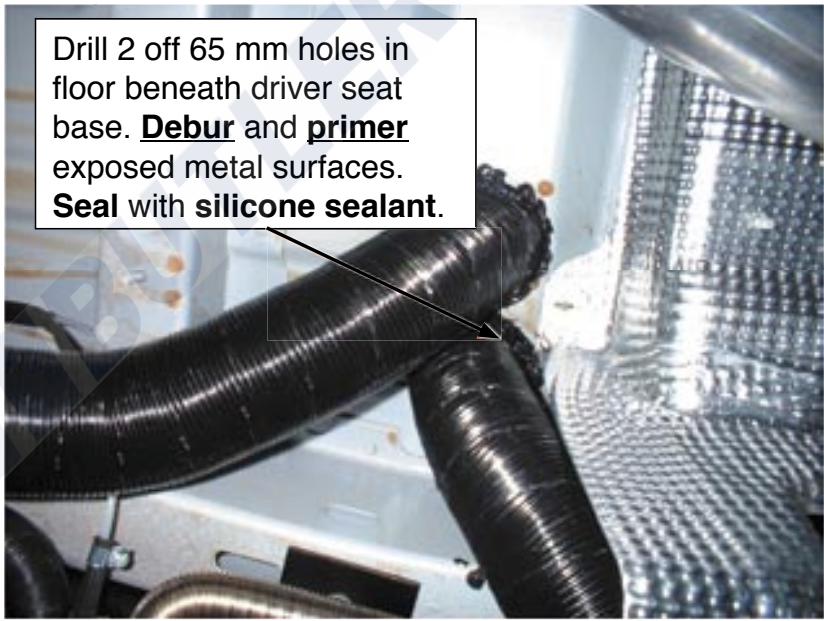
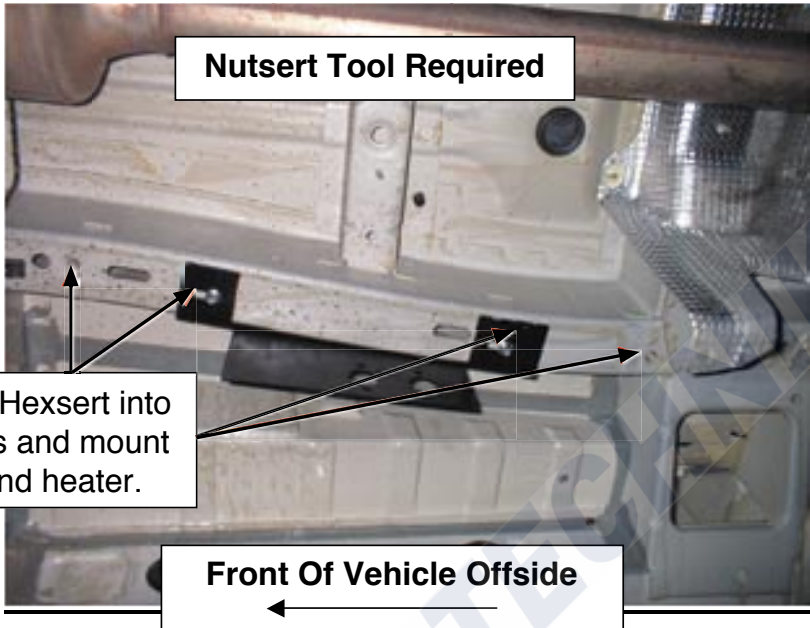

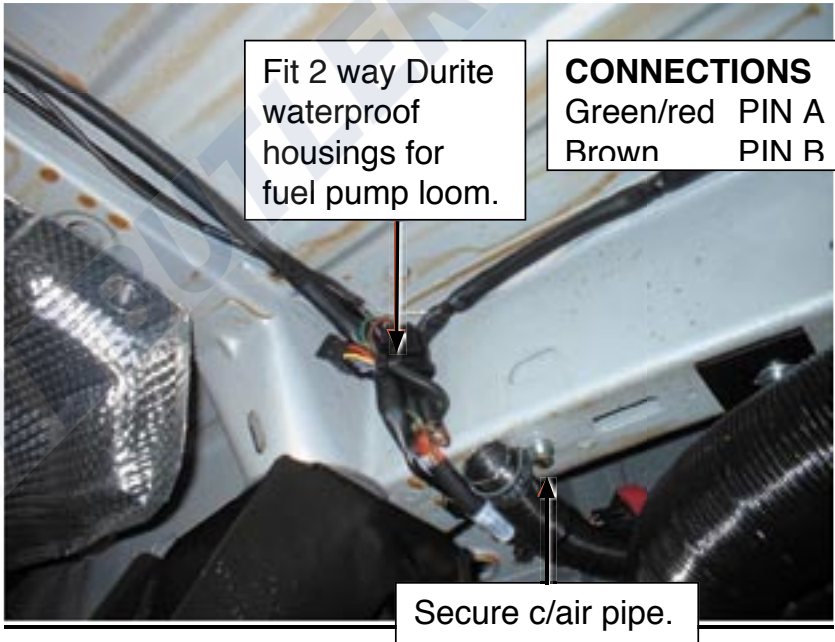
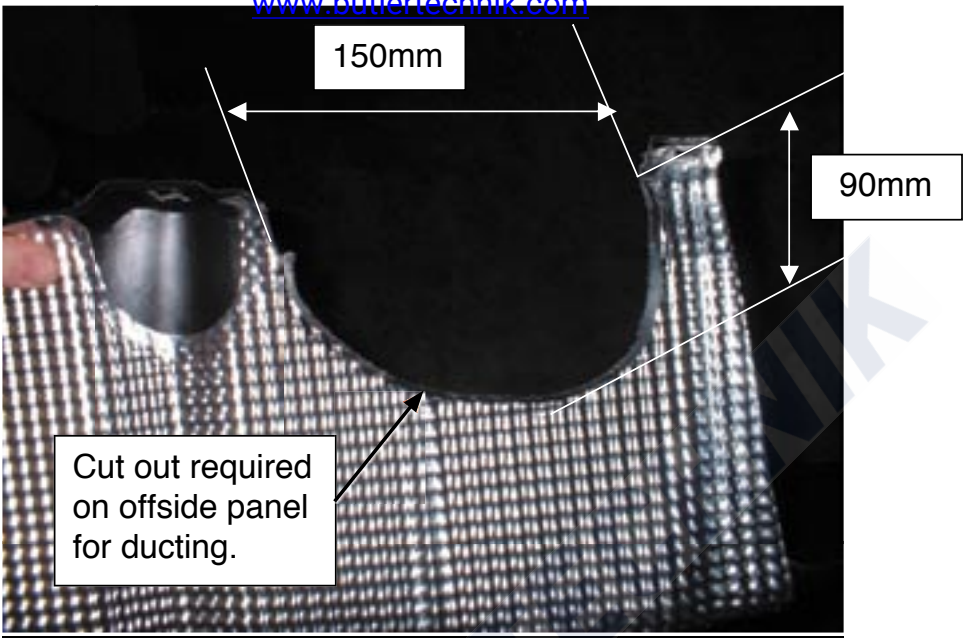

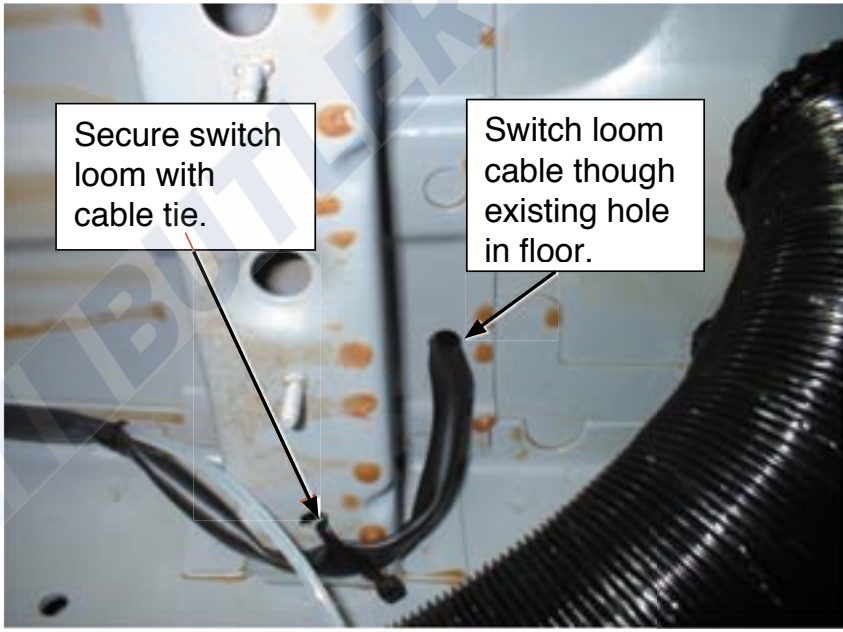
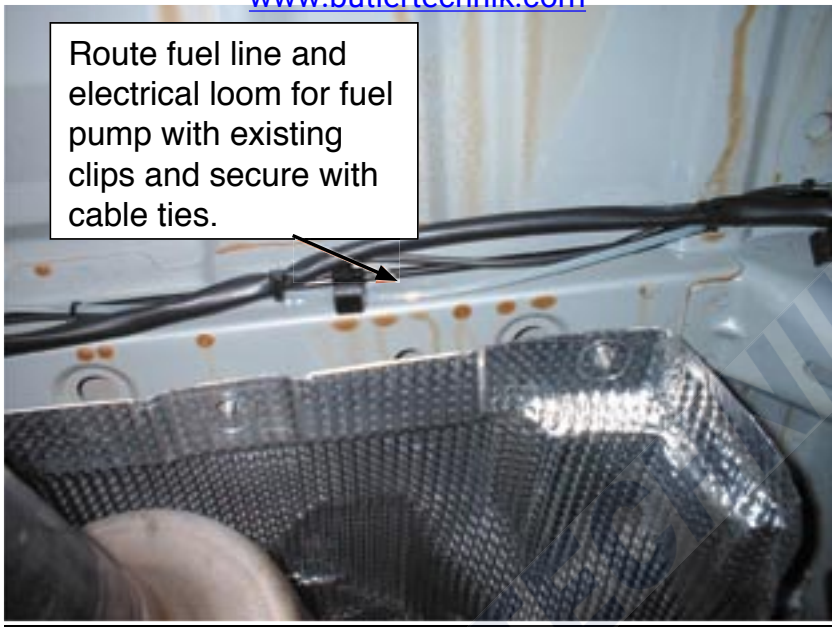

Negative cable to battery M6 ring.

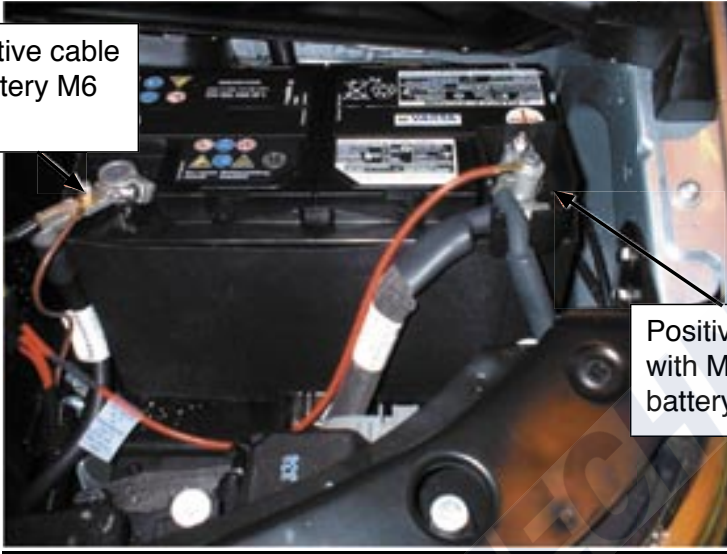

Positive cable with M6 ring to battery.

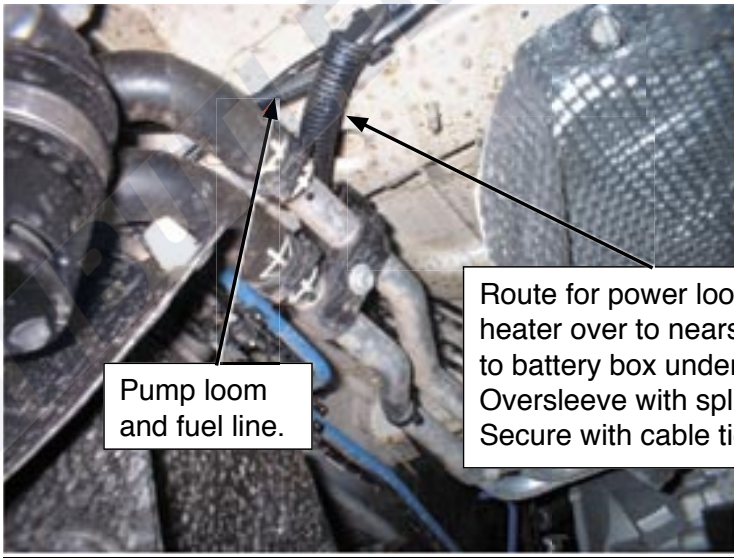

Pump loom and fuel line.

Route for power loom is from heater over to nearside and up to battery box under bonnet. Oversleeve with split conduit. Secure with cable ties.

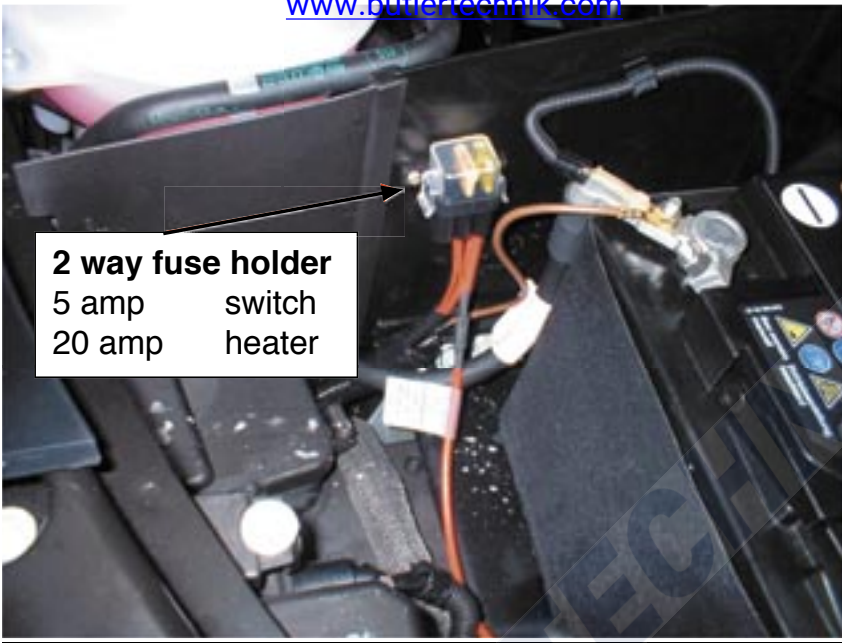

**2 way fuse holder**  
5 amp      switch  
20 amp     heater

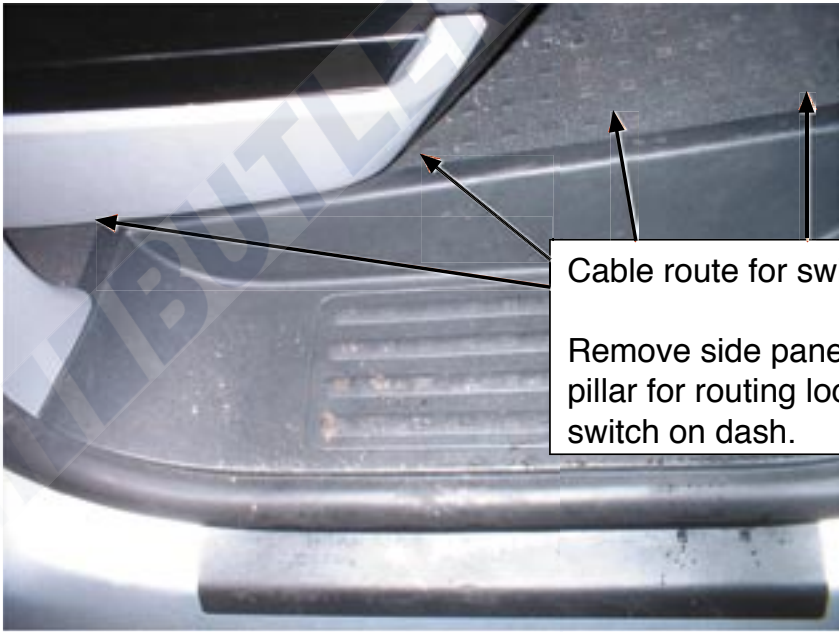

Cable route for switch loom.

Remove side panel on 'A' pillar for routing loom to switch on dash.



### Switch Wiring

Red	Pin 1
Yellow	Pin 2
Brown	Pin 3
Grey/red	Pin 4
Brown/white	Pin 5



Switch mounted on dashboard onto VW blanks.

Fuel line cut from Webasto add heater fuel pump.  
Disconnect 2 off electrical plugs to Webasto add heater.

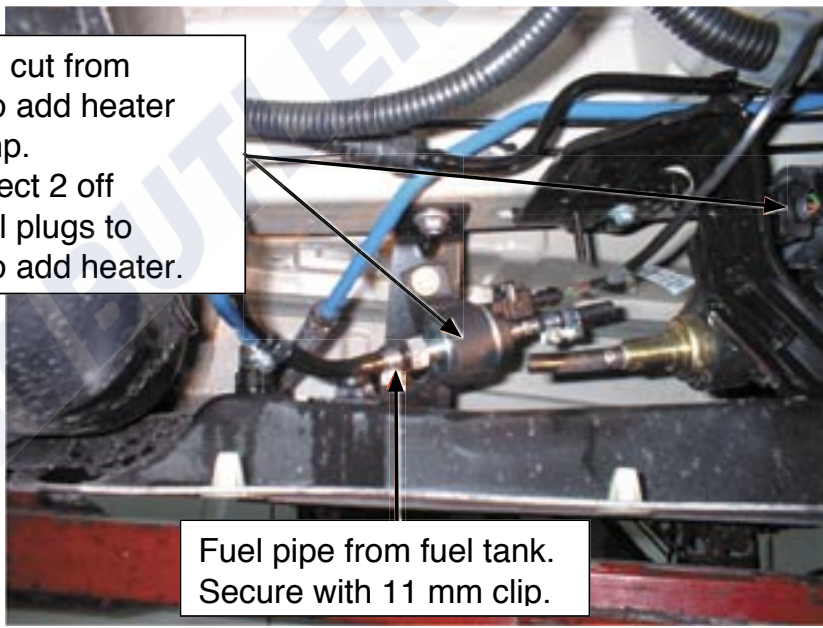

Fuel pipe from fuel tank.  
Secure with 11 mm clip.

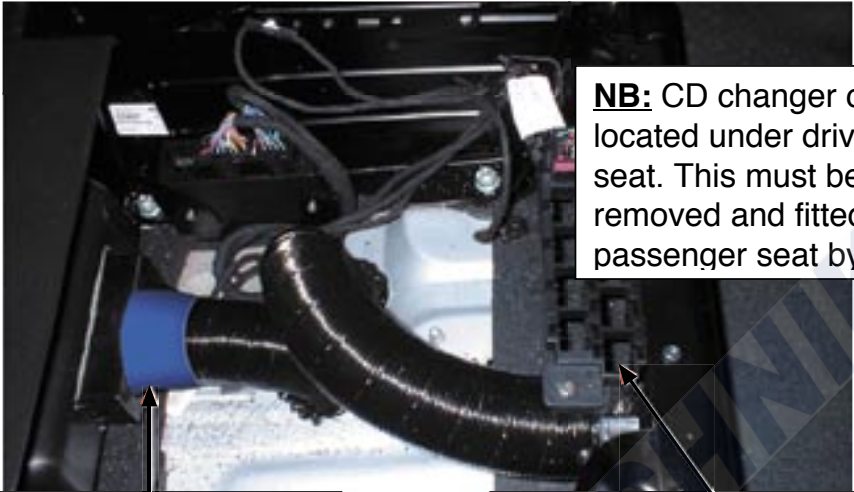

**NB:** CD changer can be located under driver seat. This must be removed and fitted under passenger seat by vw.

Blue silicone adapter to connect hot air outlet ducting to outlet.

Air inlet from front of drivers seat. Mount plastic flange and plastic grill with cable tie to relay cluster.

Cut out a 120 mm x 50 mm slot in VW plastic cowl behind drivers seat base

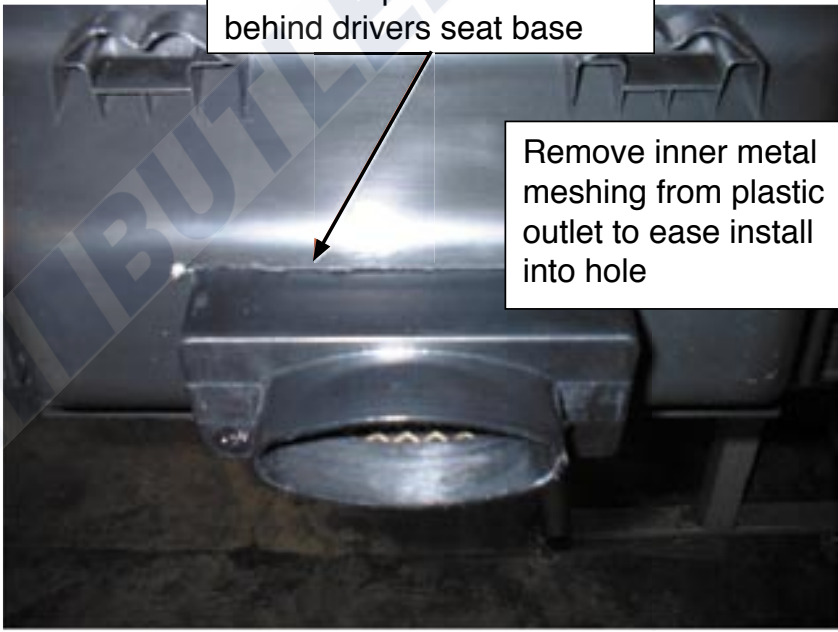

Remove inner metal meshing from plastic outlet to ease install into hole

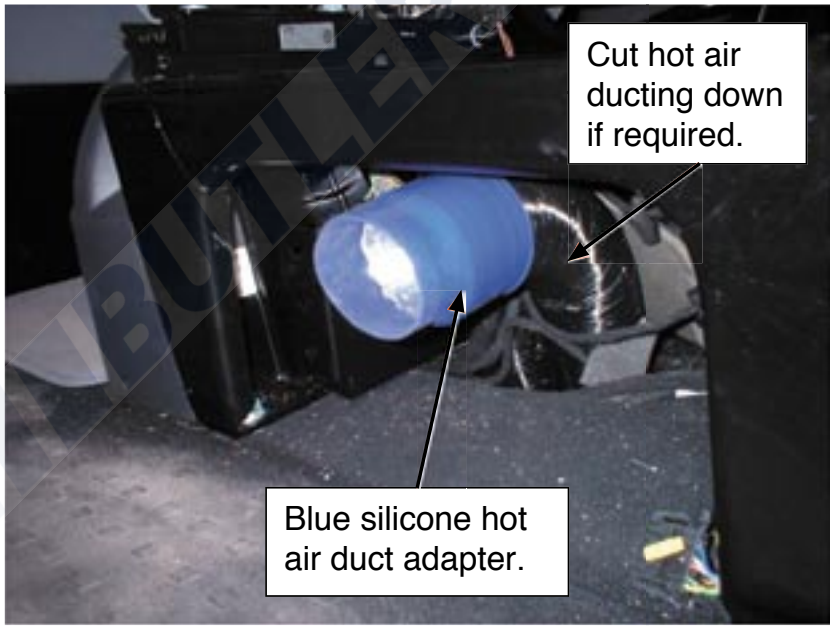
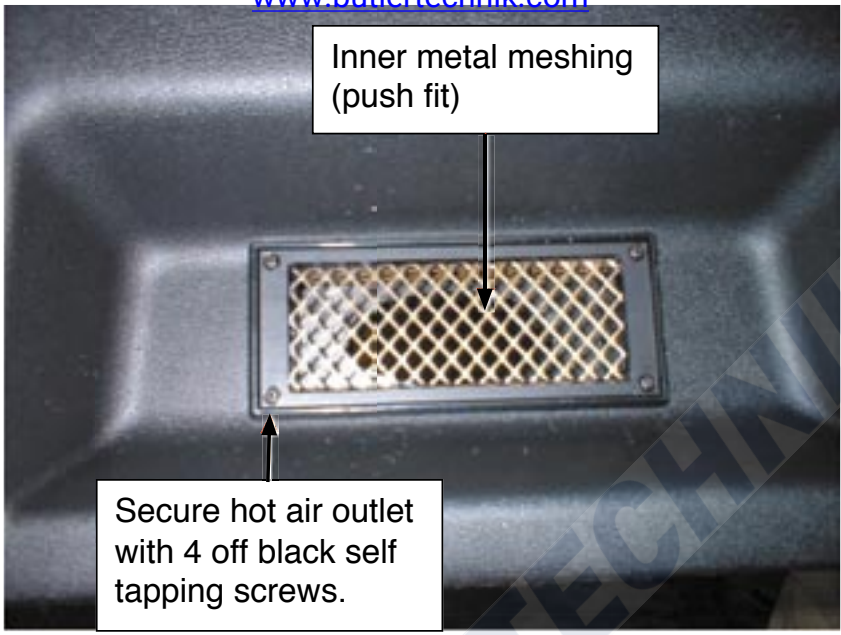



Hot air outlet.

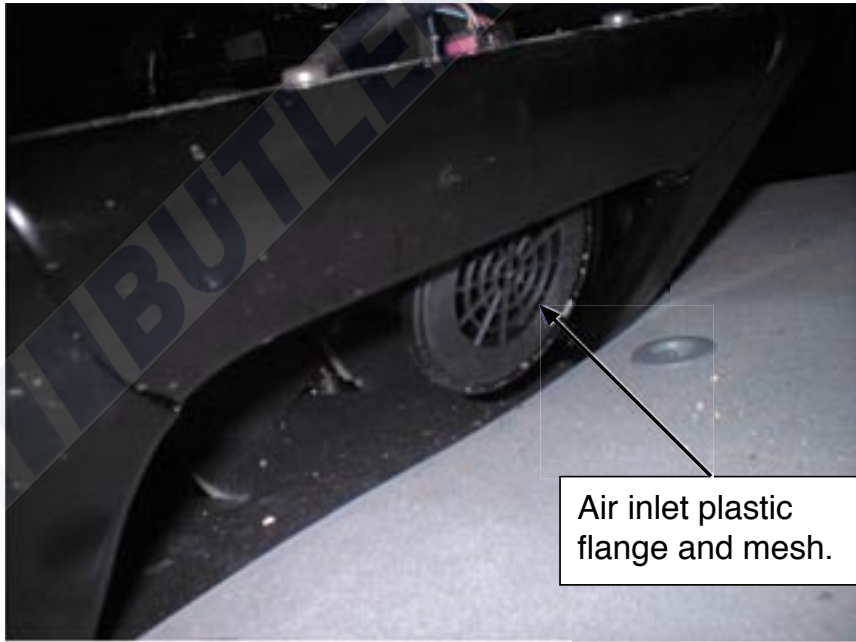

Air inlet plastic flange and mesh.

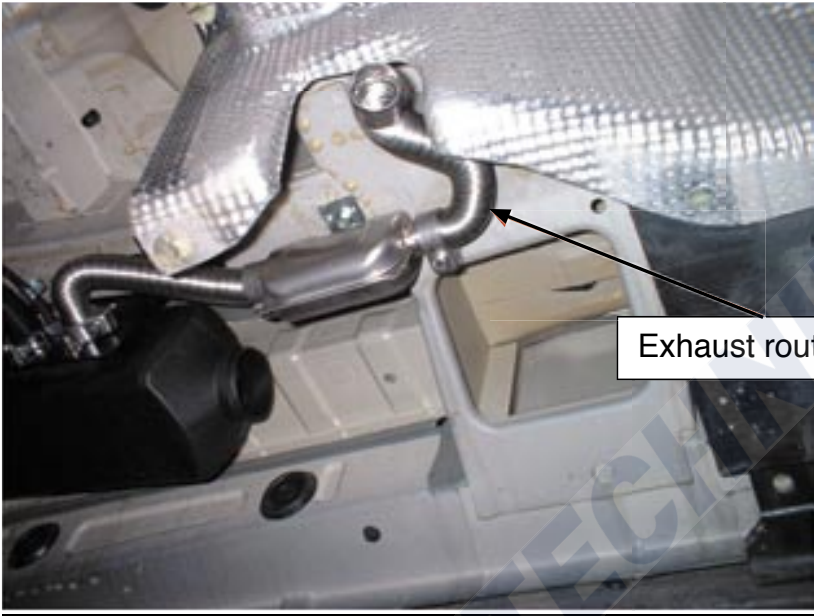

Exhaust route.

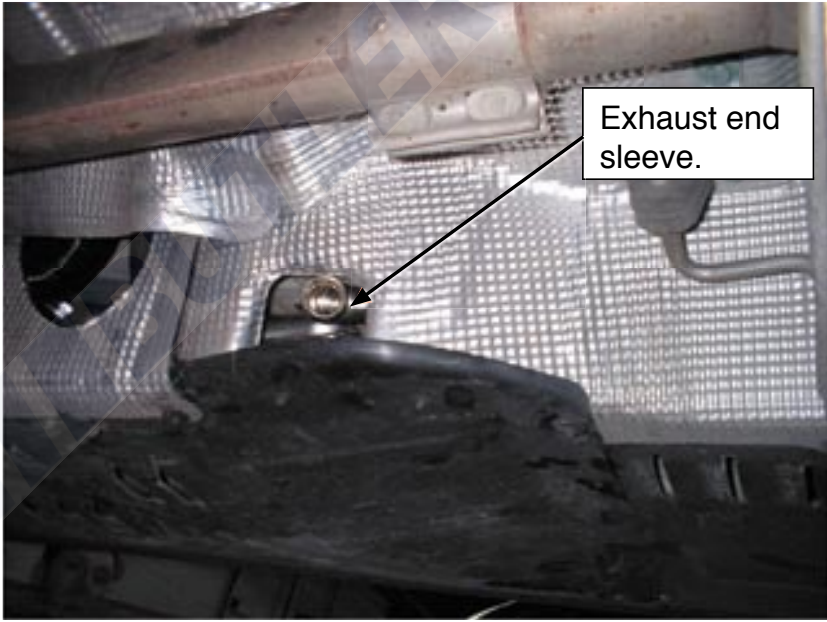

Exhaust end sleeve.



Stick duplicate serial plate from Airtronic D2 heater on drivers door pillar.

## Modification Required By VW Dealer If CD Changer Is Fitted Under Driver Seat

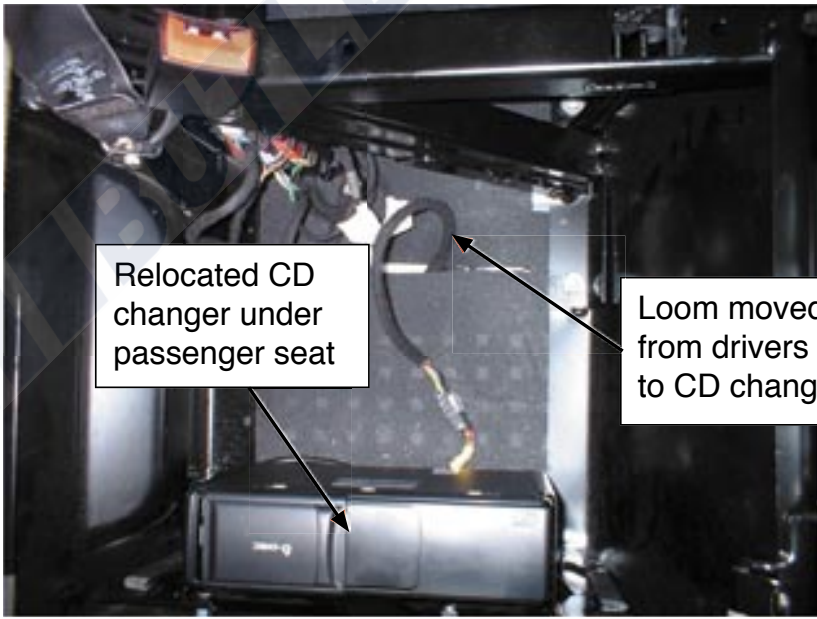

Relocated CD changer under passenger seat

Loom moved from drivers seat to CD changer

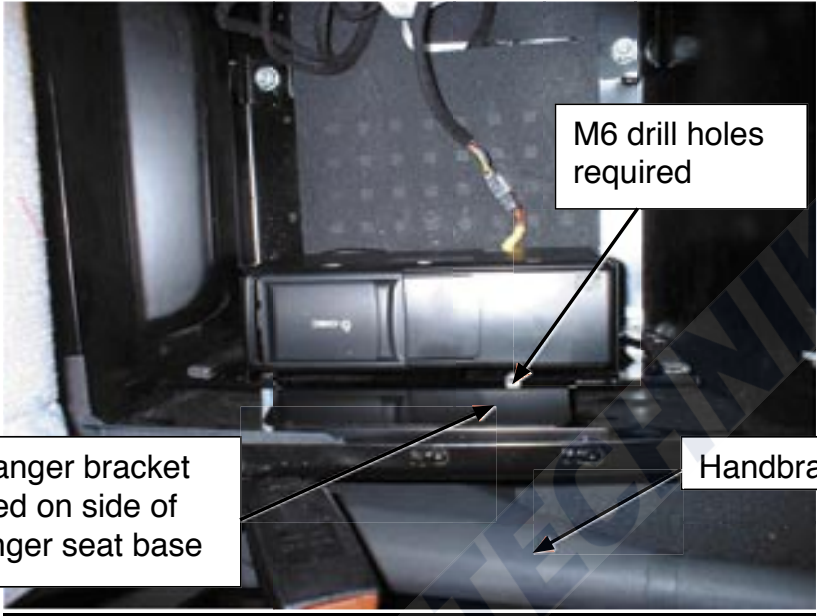

CD changer bracket  
mounted on side of  
passenger seat base

M6 drill holes  
required

Handbrake



**Eberspächer**

Uncontrolled Copy

This publication was correct at the time of going to print. However, Eberspächer (UK) Ltd. have a policy of continuous improvement and reserve the right to amend any specifications without prior notice.

© Eberspächer (U.K.) Ltd. 2004

No part of this document may be copied or reproduced without the express permission of Eberspächer (U.K.) Ltd.